

# GX-F66RC

## STEREO CASSETTE DECK

- Notes:**
- Cassette tape in photograph not included in standard accessories.
  - This manual is applicable to both silver and pearl shadow panel models.
- Remarques:**
- La bande de cassette sur la photo n'est pas comprise dans les accessoires standard.
  - Ce manuel s'applique aussi aux modèles avec panneaux argent et gris perle.
- Opmerkingen:**
- De in de foto's afgebeelde cassettes behoren niet tot het standaardtoebehoren.
  - Deze gebruiksaanwijzing is van toepassing op modellen met zilver en parel-grijs paneel.
- Anmärkningar:**
- Kassetbandet i bilderna hör inte till standard tillbehören.
  - Bruksanvisningen gäller både för modellen med silverpanel och modellen med pärlgrå panel.
- Anmerkungen:**
- Die Cassette im Bild gehört nicht zum Standardzubehör.
  - Diese Betriebsanleitung gilt auch für die Ausführung mattsilber und perl-schattenfarbig.
- Notas:**
- La cinta casete mostrada en la fotografía no está incluida como accesorio estándar.
  - Este manual cubre ambos modelos, el de panel plateado y el de panel color perla oscura.



### WARNING

To prevent fire or shock hazard, do not expose this appliance to rain or moisture.

**Operator's Manual**  
**Manuel de l'utilisateur**  
**Gebruiksaanwijzing**  
**Bruksanvisning**  
**Bedienungsanleitung**  
**Manual del usuario**

# AKAI



## WARNING

### POWER REQUIREMENT

Power requirements for electrical equipment differ from area to area. Please ensure that your machine meets the power requirements in your area.

If in doubt, consult a qualified electrician.

120V, 60 Hz for USA and Canada

220V, 50 Hz for Europe except UK

240V, 50 Hz for UK and Australia

110V/120V/220V/240V, 50/60 Hz internally switchable for other countries.

### VOLTAGE CONVERSION

#### Do Not Attempt This Conversion Yourself.

Voltage conversion (Models for Canada, USA, Europe, UK and Australia are not equipped with this facility). Each machine is preset at the factory according to destination, but some machines can be set to 110V, 120V, 220V or 240V as required. If your machine's voltage can be converted, refer the following voltage conversion to a qualified Service Repair Shop or professional service personnel.

1. Disconnect power cord.
2. Loosen holding screws of the top panel and the two top screws of the rear panel and remove top panel.
3. Remove short pin plug from present holes and replace in correct holes. Follow the markings explicitly.

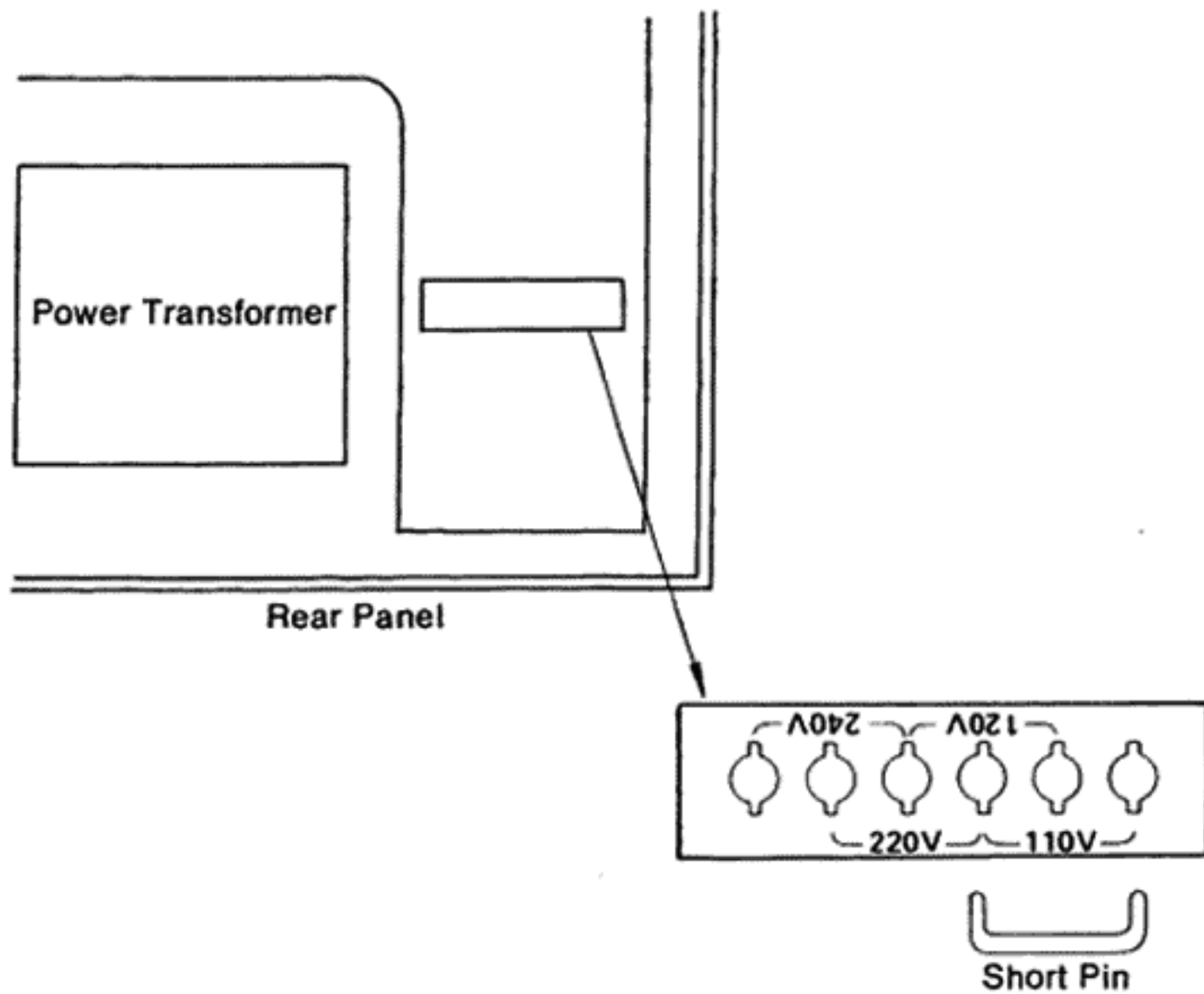

## PRECAUTIONS



**CAUTION**

RISK OF ELECTRIC SHOCK  
DO NOT OPEN



**CAUTION: TO REDUCE THE RISK OF ELECTRIC SHOCK, DO NOT REMOVE COVER (OR BACK).**  
**NO USER-SERVICEABLE PARTS INSIDE.**  
**REFER SERVICING TO QUALIFIED SERVICE PERSONNEL.**



- The lightning flash with arrowhead symbol superimposed across a graphical representation of a person, within an equilateral triangle, is intended to alert the user of the presence of uninsulated "dangerous voltage" within the product's enclosure; that may be of sufficient magnitude to constitute a risk of electric shock to persons.
- The exclamation point within an equilateral triangle is intended to alert the user of the presence of important operating and maintenance (servicing) instructions in the literature accompanying the appliance.

1. Use only household AC power sources. Never use DC power sources.
2. Always set the amplifier's volume control to minimum when turning on or off the deck.
3. Touching the plug with wet hands risks dangerous electric shocks. Always pull out by the plug and never the cord.
4. Make sure the power consumption to each audio component does not exceed wattage specified. Only connect other audio components.
5. Only let a qualified professional repair or reassemble the equipment. An unauthorized person may touch the internal parts and receive a serious electric shock.
6. Never allow a child to put anything, especially metal into this equipment. A serious shock or malfunction may occur.
7. If water is spilled on this equipment, disconnect and call your dealer.
8. Make sure the equipment is well ventilated and away from direct sunlight.
9. Keep away from heat (stoves, etc.) to avoid damage to the external surface and internal circuits.
10. Avoid spray-type insecticides which will damage the equipment and may ignite suddenly.
11. To avoid damaging the finish never use alcohol, paint thinner or others similar chemicals.
12. Always place the equipment on a flat and solid surface.
13. Please read this manual in its entirety and keep it handy for further reference.

**This equipment confirms to No. 76/889/EEC standard.**

### DEW FORMATION

Dew is the term used for the formation of moisture on the very important transport section such as the head and the capstan when the deck is used in places where the humidity is high, subjected to sudden changes in temperature or moved from a cold place to a warm one. If the deck is used when dew is present, the tape will stick to the head and be ruined or tape will not be transport properly. In such cases, do not use the deck for approximately one hour until the deck is acclimatized.

# CONTROLS

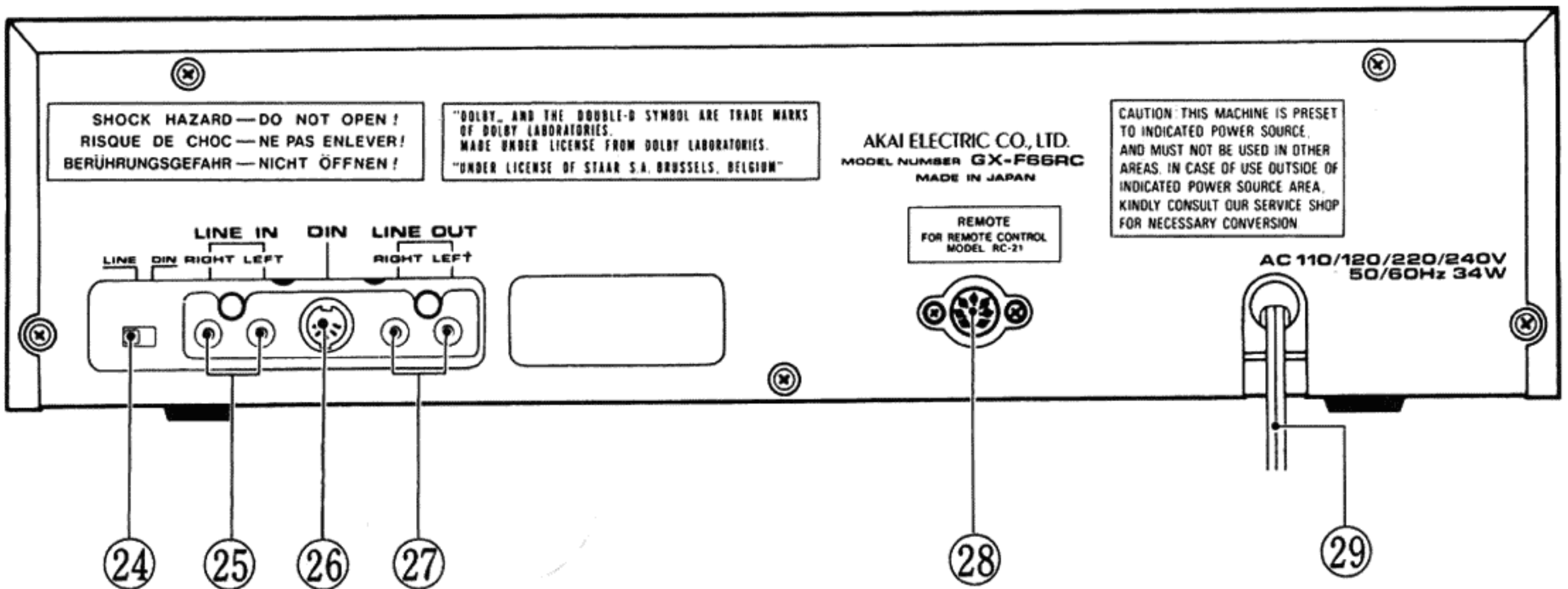
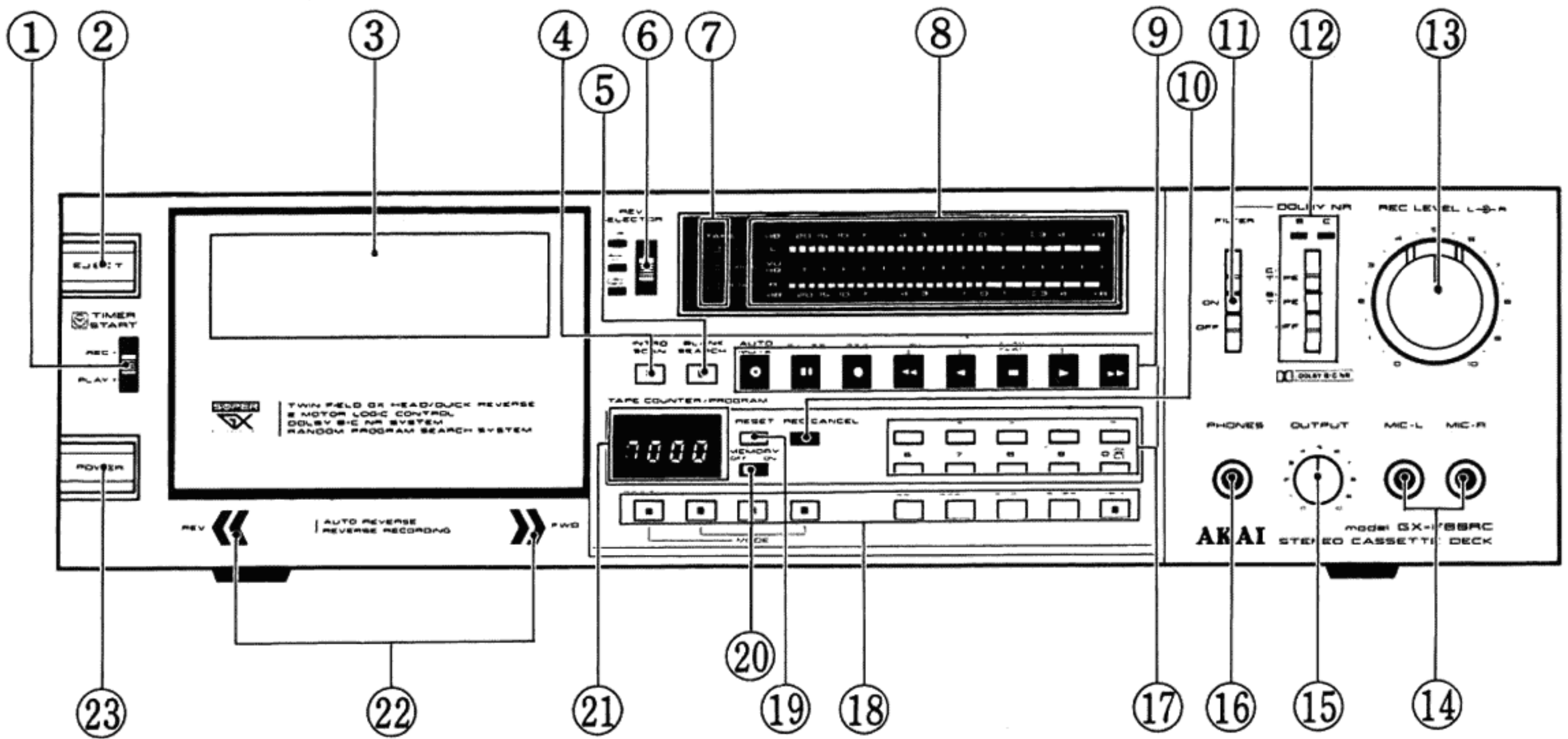



1. **TIMER START Selector**  
 REC: For absentee recording with a timer.  
 OFF: For all other times when the Timer Start operation is not to be engaged.  
 PLAY: For timed playback with a timer.
2. **EJECT Button**
3. **Cassette Receptacle**
4. **INTRO SCAN Button**  
 Press the button and beginning of each selection will be played back for 10 seconds.  
 \* Its indicator will light.
5. **BLANK SEARCH Button**  
 Press this button and the deck will find a blank portion on the tape and then go into recording standby mode.
6. **Reverse (REV) SELECTOR**  
 →: For one-way (forward or reverse) recording or playback.  
 ⇄: For once-cycle (forward to reverse) recording or playback.  
 ⇄: For continuous playback. Recording will take place as in ⇄.
7. **TAPE Indicators**  
 Inter-connected with the auto tape selector. When a cassette is loaded, the indicator (CrO<sub>2</sub>: Chrome, NORMAL: Low noise and low noise high output, or METAL: metal) corresponding to the type of tape loaded will light. At the same time, the bias and equalization will be automatically adjusted for the type of tape.
8. **LED Bar Meter with Maximum Hold**  
 Shows recording input levels and playback levels. The maximum levels over 0 dB will be held for approximately 1 second.
9. **Operating Buttons**  
 \* For stable Timer Start operation, the Operating buttons will not be activated for approximately 5 seconds after the power has been turned on.  
**AUTO MUTE (●) Button**  
 Press this button during recording to put the deck into no-signal mode. No recording will be made on the tape.  
**PAUSE (■) Button**  
 Press this button to temporarily stop tape travel.  
 \* Does not function during fast forward and rewind modes.  
**Recording [REC (●)] Button**  
 Press this button and the Forward (▶) button simultaneously for forward recording. Press this button and the Reverse (◀) button simultaneously for reverse recording.  
**Rewind (◀◀) Button**  
 Press this button to rewind the tape in the direction of the arrows.  
**Reverse (◀) Button**  
 Press this button for reverse playback.  
 \* The Reverse Direction indicator (REV <<) will light when this button is pressed.  
**Stop (■) Button**  
 Press this button to stop tape travel and to stop pause, recording, fast forward, rewind and playback modes.  
**Forward (▶) Button**  
 Press this button for forward playback.  
 \* The Forward Direction indicator (FWD >>) will light when this button is pressed.  
**Fast Forward (▶▶) Button**  
 Press this button to fast forward the tape in the direction of the arrows.
10. **Recording (REC) CANCEL Button**  
 Press this button during recording and the deck will rewind the tape to the beginning of the selection that was being recorded; erase the first 4 seconds of tape and then go into recording standby mode.  
 \* Use the AUTO MUTE (●) button to create blank spaces between the selections.  
 \* If there are noise recorded between the selections, the operation may not function properly.
11. **FILTER Switch**  
 ON: Set to this position when recording with Dolby C-Type NR or B-Type NR from FM stereo broadcasts.  
 OFF: Set to this position at all other times.
12. **DOLBY NR Selector with Indicators**  
 C-TYPE: Use for recording or playback with Dolby C-Type NR.  
 B-TYPE: Use for recording or playback with Dolby B-Type NR.  
 OFF: Use for recording or playback without Dolby C-Type NR and B-Type NR.  
 \* The indicator will go off when set to this position.
13. **Left ↔ Right Recording Level Controls (REC LEVEL L ↔ R)**  
 The outer ring controls the right channel recording input level and the inner knob controls the left channel recording input level. The controls are coaxial, therefore they may be adjusted independently or together.
14. **Microphone (MIC-L: left, MIC-R: right) Jacks**  
 Connect two microphones for stereo recording. Connect one microphone to the left jack for monaural recording.  
 \* Some models have a MONO MIC jack. Connect to this jack for monaural recording.
15. **OUTPUT Control**  
 Can adjust simultaneously the line output and headphone output.  
 \* Not inter-connected to the LED Bar Meter.
16. **Headphone (PHONES) Jack**  
 Accommodates stereo headphones of 8 ohms impedance for monitoring or private headphone listening.
17. **Programming Keys (1 to 0 □)**  
 Use for programming and confirming the programs. To confirm how many times a program is to be repeated, press the 0 □ key.
18. **Random Program Search System (RPSS) Keys**  
 RPSS takes priority over Memory operation and REV SELECTOR.  
**PROGRAM Key:** Press to activate the RPSS. Its indicator and the SEQ key's indicator will light.  
**Sequence (SEQ) Key:** Press for Sequential Play.  
**RANDOM Key:** Press for Random Play.  
**SKIP Key:** Press for Skip Play.  
**SET Key:** Press to memorize a program.  
**CLEAR Key:** Press to cancel a program and when "Err" is displayed.  
**REPEAT Key:** Press to program how many times a program is to be repeated.  
**CALL Key:** Press to confirm a program.  
**RUN Key:** Press to put a program into action.
19. **MEMORY Switch**  
 When set to ON position, the deck will fast forward or rewind the tape to "0000" and stop. If engaged in conjunction with the Auto-play, the deck will automatically begin playback when "0000" is reached. Set to the OFF position when the Memory operation is not to be engaged.
20. **RESET Button**  
 Press this button to reset the LED TAPE COUNTER/PROGRAM display to "0000".
21. **TAPE COUNTER/PROGRAM Display**  
 During normal tape travel, the display becomes a 4-digit tape counter. The numbers will increase when the tape is travelling in the forward direction and will decrease when the tape is traveling in the reverse direction. During RPSS operation, the display will show the program number in 2-digits. When there is an error during RPSS operation, the display will show "Err".
22. **Direction Indicators**  
 Indicate the direction of tape travel during recording and playback modes and indicates direction standby during rewind, fast forward, and stop modes.  
 REV << : Reverse direction  
 FWD >> : Forward direction
23. **POWER Switch**  
 Press to turn on the power and press again to turn off the power.
24. **LINE/DIN Selector (Some models do not have this facility.)**  
 LINE: Set to this position for input from the LINE IN jacks.  
 DIN: Set to this position for input from the DIN jacks.
25. **LINE IN Jacks (RIGHT and LEFT)**  
 Connect to the outputs of an amplifier, tape deck or recorder.
26. **DIN Jack (Some models do not have this facility.)**  
 Can be used instead of the LINE IN and OUT jacks for connection with an external amplifier through a DIN connection cord.
27. **LINE OUT Jacks (RIGHT and LEFT)**  
 Connect to the inputs of an amplifier, tape deck or recorder.
28. **REMOTE Control Jack**  
 Connect the optional Remote Control Unit RC-90 or RC-21 for remote control operation.  
 \* Use only an Akai recommended connection cord.
29. **Power Cord (Some models are equipped with an AC Inlet instead. Connect with the connection cord supplied.)**



## FOR CUSTOMERS IN THE UK IMPORTANT FOR YOUR SAFETY

The flex supplied with your machine will have either two wires or three as shown in the illustrations.

### THREE CORE FLEX WARNING

#### THIS APPARATUS MUST BE EARTHED IMPORTANT

The wires in this mains lead are coloured in accordance with the following code: Green-and-yellow: Earth  
Blue: Neutral  
Brown: Live

As the colours of the wires in the mains lead of this apparatus may not correspond with the coloured markings identifying the terminals in your plug, proceed as follows:

The wire which is coloured green-and-yellow must be connected to the terminal in the plug which is marked by the letter E or by the safety earth symbol  $\equiv$  or coloured green or coloured green-and-yellow.

The wire which is coloured blue must be connected to the terminal which is marked with the letter N or coloured black.

The wire which is coloured brown must be connected to the terminal which is marked with the letter L or coloured red.

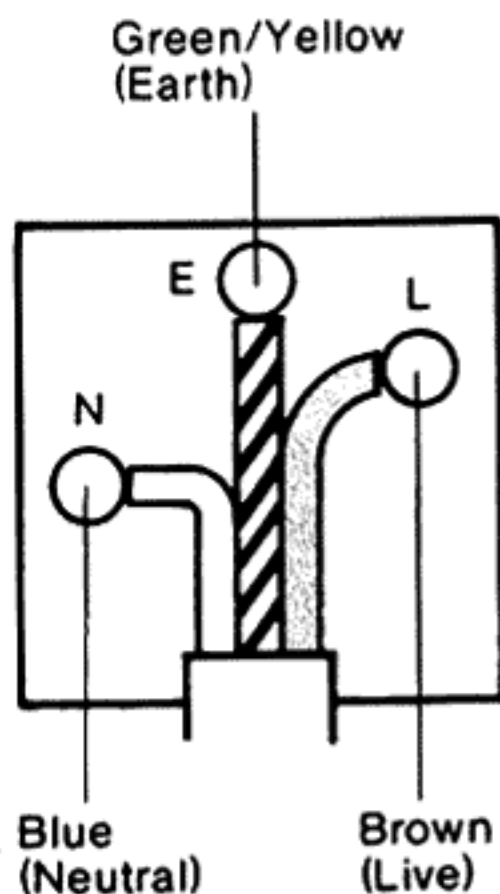

### TWO CORE FLEX IMPORTANT

The wires in this mains lead are coloured in accordance with the following code: Blue: Neutral  
Brown: Live

As the colours of the wires in the mains lead of this apparatus may not correspond with the coloured markings identifying the terminals in your plug, proceed as follows:

The wire which is coloured blue must be connected to the terminal which is marked with the letter N or coloured black.

The wire which is coloured brown must be connected to the terminal which is marked with the letter L or coloured red.

\* Do not connect any wire to the larger pin marked E or  $\equiv$  when wiring a plug. Ensure that all terminals are securely tightened and that no loose strands of wire exist.

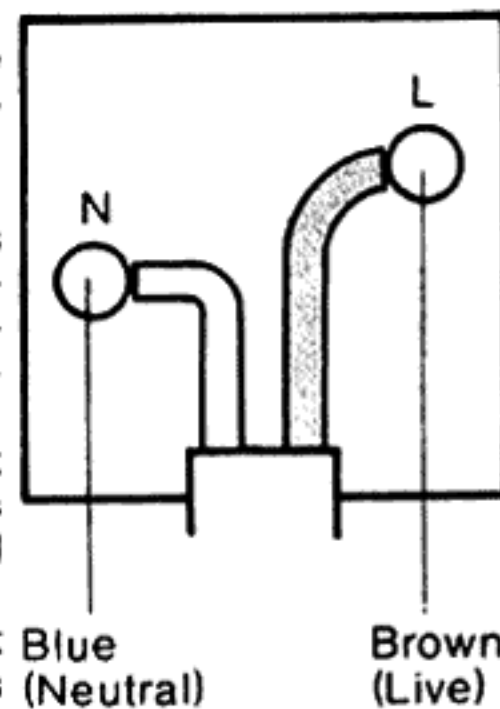

## FOR CUSTOMERS IN AUSTRALIA

If your machine comes with a three core power cord, FOR YOUR SAFETY.

1. Insert this plug only into an effectively earthed three-pin plug socket outlet.
2. If any doubt exists regarding the earthing, consult a qualified electrician.
3. Extension cords, if used, must be three core correctly wired.

## FOR CUSTOMERS IN THE U.S.A.

### SAFETY INSTRUCTIONS

1. **Read Instructions** — All the safety and operating instructions should be read before the equipment is operated.
2. **Retain Instructions** — The safety and operating instructions should be retained for future reference.
3. **Heed Warnings** — All warnings on the equipment and in the operating instructions should be adhered to.
4. **Follow Instructions** — All instructions for operating and use should be followed.
5. **Water and Moisture** — The equipment should not be used near water — for example, near a bathtub, washbowl, kitchen sink, laundry tub, in a wet basement, or near a swimming pool, etc.
6. **Carts and Stands** — The equipment should be used only with a cart or stand that is recommended by Akai.
7. **Wall or Ceiling Mounting** — Akai does not recommend mounting the equipment on a wall or a ceiling.
8. **Ventilation** — The equipment should be situated so that its location or position does not interfere with its proper ventilation. For example, the equipment should not be situated on a bed, sofa, rug, or similar surface that may block the ventilation openings; or, placed in a built-in installation, such as a bookcase or cabinet that may impede the flow of air through the ventilation openings.
9. **Heat** — The equipment should be situated away from heat sources such as radiators, heat registers, stoves, or other equipments (including amplifiers) that produce heat.
10. **Power Sources** — The equipment should be connected to a power supply only of the type described in the operating instructions or as marked on the equipment.
11. **Grounding or Polarization** — The precautions should be taken so that the grounding or polarization means of an equipment is not defeated.
12. **Power-Cord Protection** — Power-supply cords should be routed so that they are not likely to be walked on or pinched by items placed upon or against them, paying particular attention to cords at plugs, convenience receptacles, and the point where they exit from the equipment.
13. **Cleaning** — The equipment should be cleaned only as recommended by the manufacturer.
14. **Power Lines** — An outdoor antenna should be located away from power lines.
15. **Outdoor Antenna Grounding** — If an outside antenna is connected to the receiver, be sure the antenna system is grounded so as to provide some protection against voltage surges and built up static charges. Section 810 of the National Electrical Code, ANSI/NFPA No. 70—1981, provides information with respect to proper grounding of the mast and supporting structure, grounding of the lead-in wire to an antenna discharge unit, size of grounding conductors, location of antenna-discharge unit, connection to grounding electrodes, and requirements for the grounding electrode. See Figure 1.
16. **Nonuse Periods** — The power cord of the equipment should be unplugged from the outlet when left unused for a long period of time.
17. **Object and Liquid Entry** — Care should be taken so that objects do not fall and liquids are not spilled into the enclosure through openings.
18. **Damage Requiring Service** — The equipment should be serviced by qualified service personnel when:
  - A. The power-supply cord or the plug has been damaged; or
  - B. Objects have fallen, or liquid has been spilled into the equipment
  - C. The equipment has been exposed to rain; or
  - D. The equipment does not appear to operate normally or exhibits a marked change in performance; or
  - E. The equipment has been dropped, or the enclosure damaged.
19. **Servicing** — The user should not attempt to service the equipment beyond that described in the operating instructions. All other servicing should be referred to qualified service personnel.

FIGURE 1  
EXAMPLE OF ANTENNA GROUNDING AS  
PER NATIONAL ELECTRICAL CODE INSTRUCTIONS

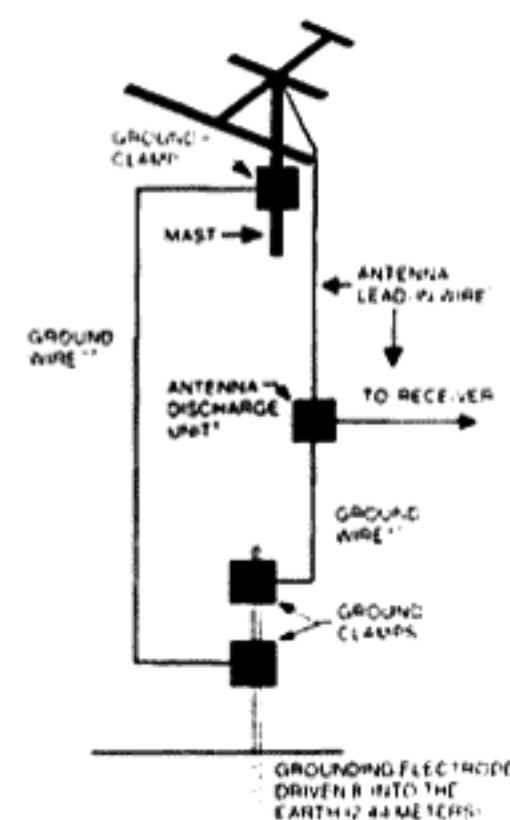

- a Use No. 10 AWG (5.3 mm<sup>2</sup>) copper, No. 8 AWG (8.4 mm<sup>2</sup>) aluminum, No. 17 AWG (1.0 mm<sup>2</sup>) copper-clad steel or bronze wire, or larger, as ground wire.
- b Secure antenna lead-in and ground wires to house with stand-off insulators spaced from 4 feet (1.22 m) to 6 feet (1.83 m) apart.
- c Mount antenna discharge unit as close as possible to where lead-in enters house.

# CASSETTE TAPE

## TAPE LOADING

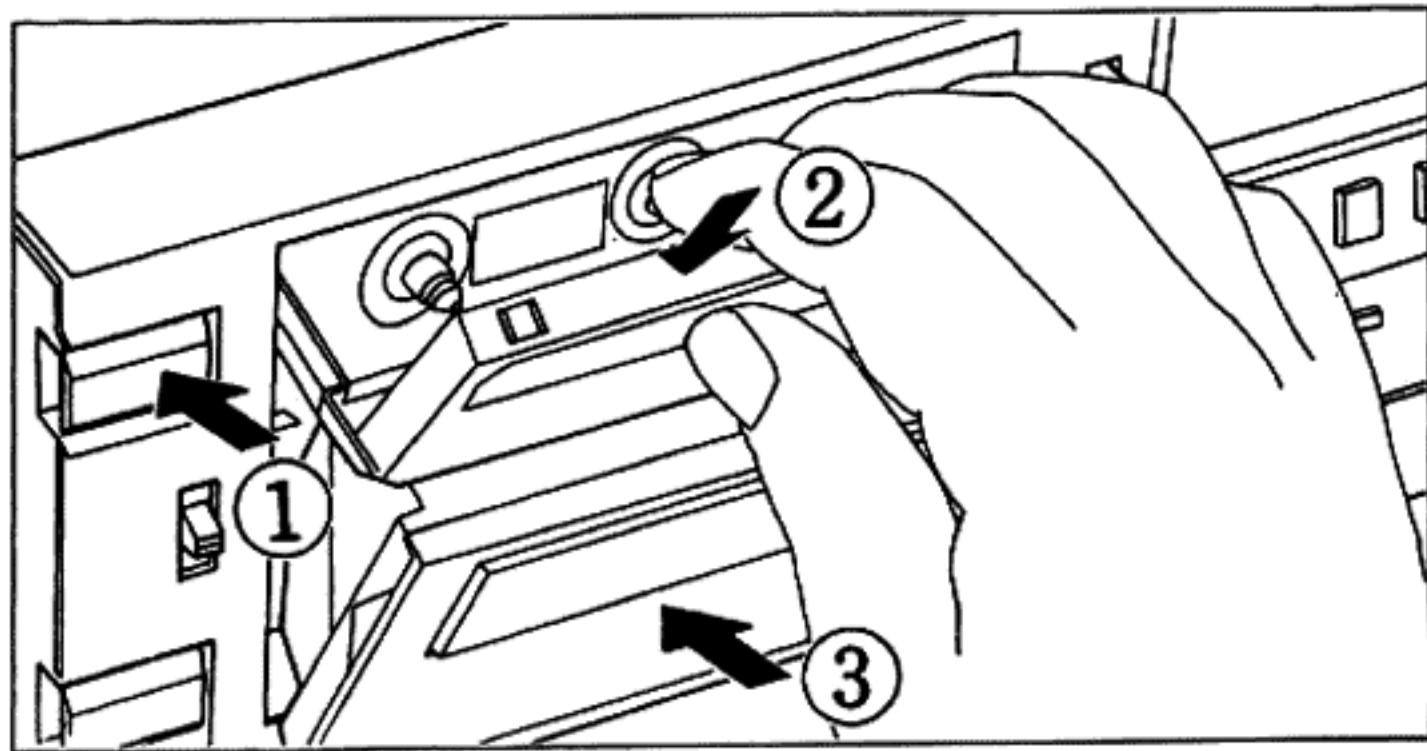

1. Depress the EJECT button to open the cassette receptacle.
2. Insert the cassette with tape facing the heads.
3. Close the lid.

## STANDARD REFERENCE AND RECOMMENDED TAPES

Types of Tape	Recommended Tapes	
NORMAL	AKAI FUJI MAXELL  SCOTCH  TDK SONY	LN FL, FX-I LN, UL, UD*, XL XL-I, XL-IS Dynarange Master I D, AD, OD HF
CrO <sub>2</sub> (CHROME)	TDK FUJI MAXELL SCOTCH	SA*, SA-X FX-II XL-II, XL-IIS Master II
METAL	AKAI TDK FUJI SCOTCH MAXELL	MT, MX MA*, MA-R METAL Metafine MX

\* C-60 tapes with this mark are the standard reference tapes.

## CASSETTE TAPE CARE

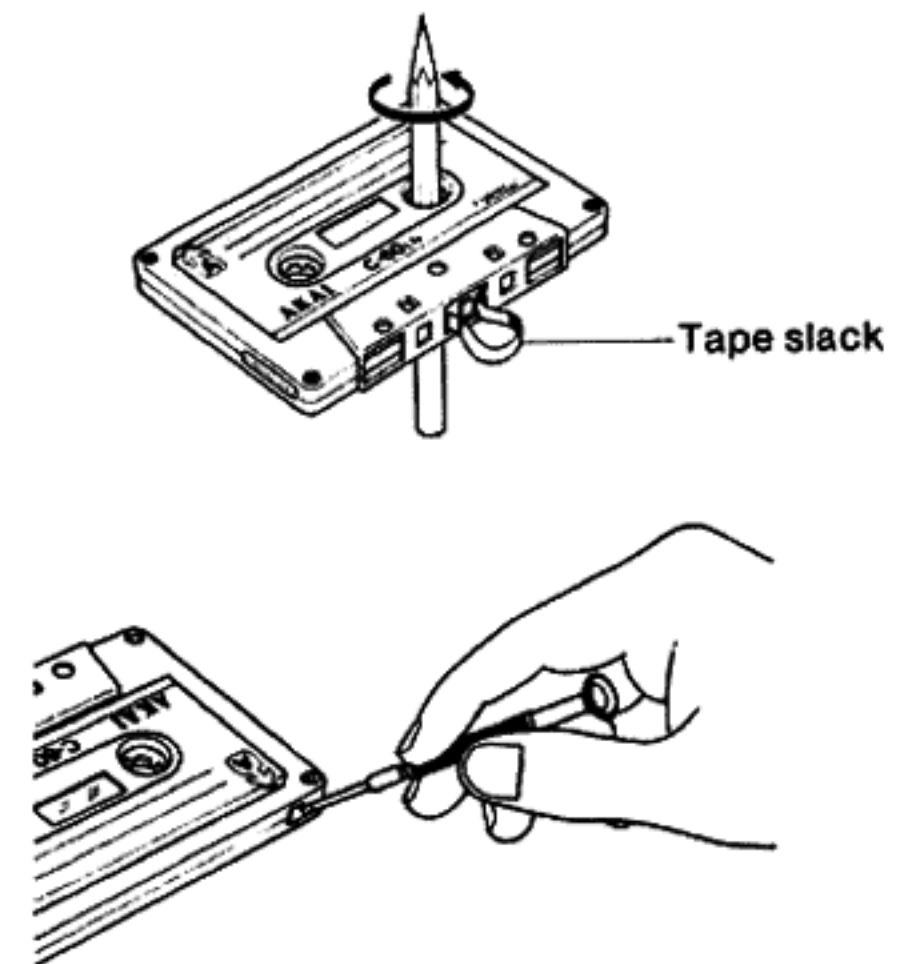

- \* Do not use cassette tape of inferior quality.
- \* For quick reverse operation, always use a tape with leader tape sections.
- \* Use a tape with very clear leader tape sections.
- \* Do not use cassette tape with printings on the leader tape sections.
- \* Heads should be kept clean and demagnetized at all times.
- \* Before using a cassette tape, confirm whether tape slack exists. As tape slack causes the tape to twist or tangle around the pinch wheel and capstan, take up slack if necessary.
- \* Recording cannot be made on the leader tape. Therefore, when using a new cassette tape, be sure to forward the tape slightly so that the leader tape is not in the head path.
- \* Tapes which have been stored in a hot moist place for a period of time or cassette tape with bent cases should not be used. Such tapes may curl or have greasy places altering tape speed and preventing proper performance. Always store tapes in a cool, dry place.
- \* Do not touch the tape with your fingers as high frequency signals cannot be recorded in places which are not clean on the tape.
- \* Cassette tapes are equipped with a break-out tab for both A and B sides. When these tabs have been removed to protect an important recording, no further recording can be made on the tape unless the cavities are plugged or covered with a piece of tape.

## AUTO TAPE SELECTOR

### A Metal cassette tape

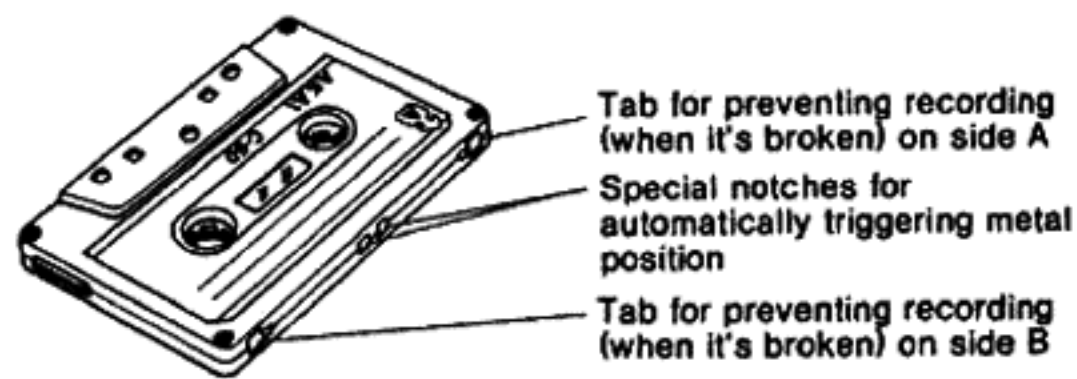

### B Chrome oxide cassette tape

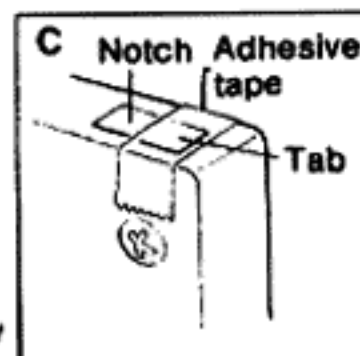
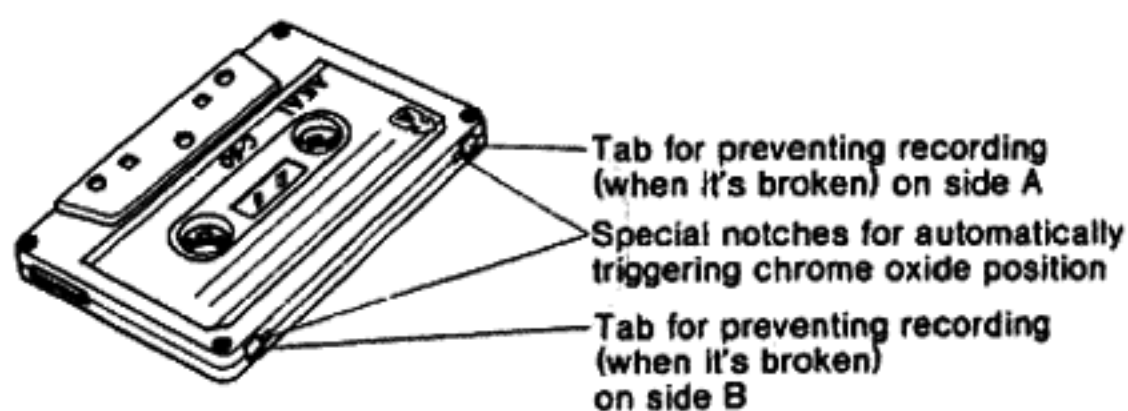

When a tape is loaded, the indicator (CrO<sub>2</sub>: Chrome, NORMAL: Low noise and low noise high output, or METAL: Metal) corresponding to the type of tape loaded will light. At the same time, the bias and equalization will be automatically adjusted for the type of tape.

- \* After loading a cassette, confirm that the indicator lit corresponds to the type of tape written on the cassette.
- \* Chrome and metal tape cassettes without notches for triggering their respective tape positions can not obtain good recording results with this deck. Use of ferri-chrome tapes are not recommended.



# CONNECTIONS

## BASIC CONNECTION

GX-F66RC

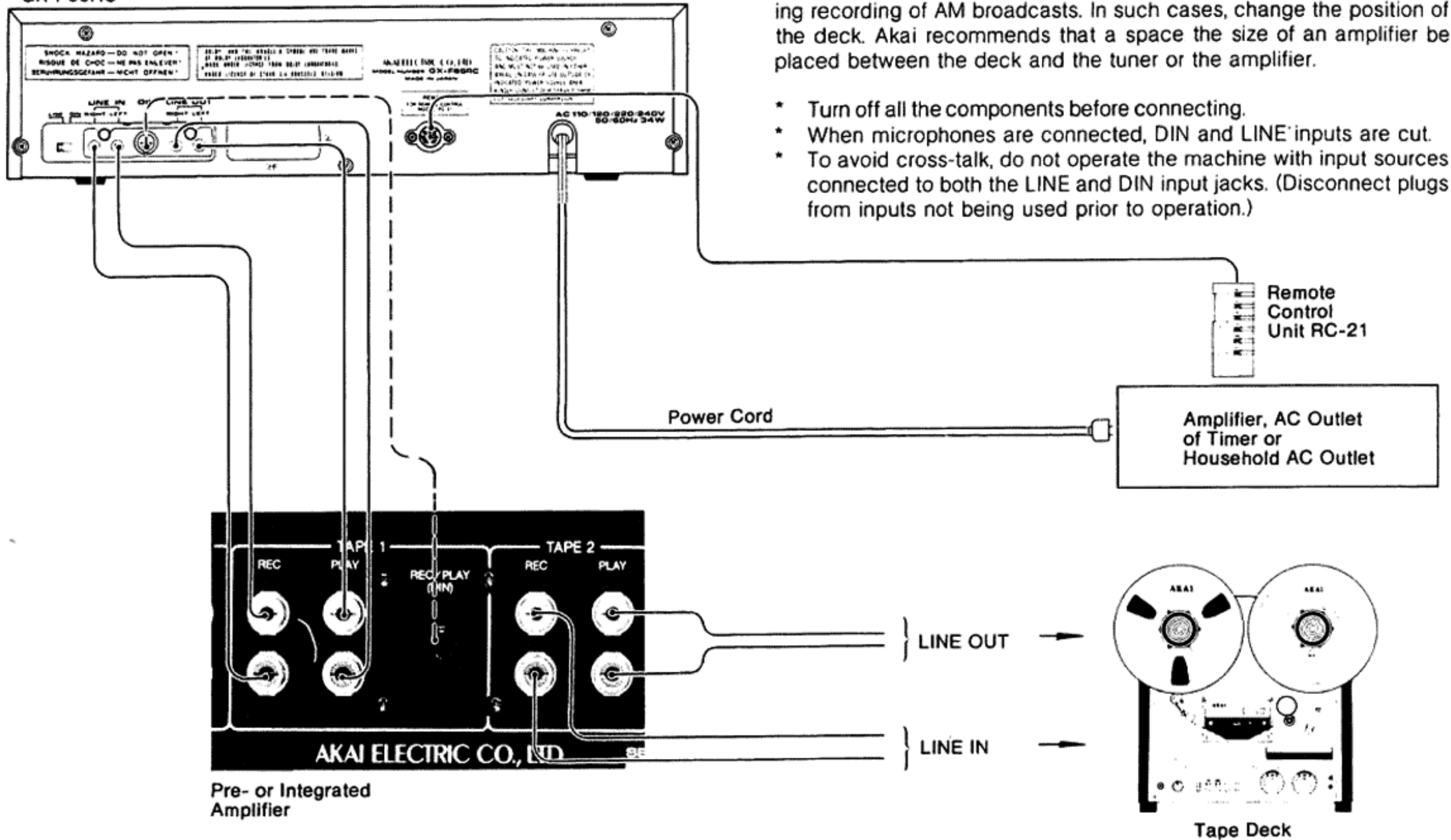

## PLACEMENT

If the deck, tuner and amplifier are placed on top of each other, humming noise may result during playback. Also beat noise may result during recording of AM broadcasts. In such cases, change the position of the deck. Akai recommends that a space the size of an amplifier be placed between the deck and the tuner or the amplifier.

- \* Turn off all the components before connecting.
- \* When microphones are connected, DIN and LINE inputs are cut.
- \* To avoid cross-talk, do not operate the machine with input sources connected to both the LINE and DIN input jacks. (Disconnect plugs from inputs not being used prior to operation.)

## WHEN TAPE DUBBING (CONNECTING DIRECTLY TO ANOTHER DECK)

GX-F66RC

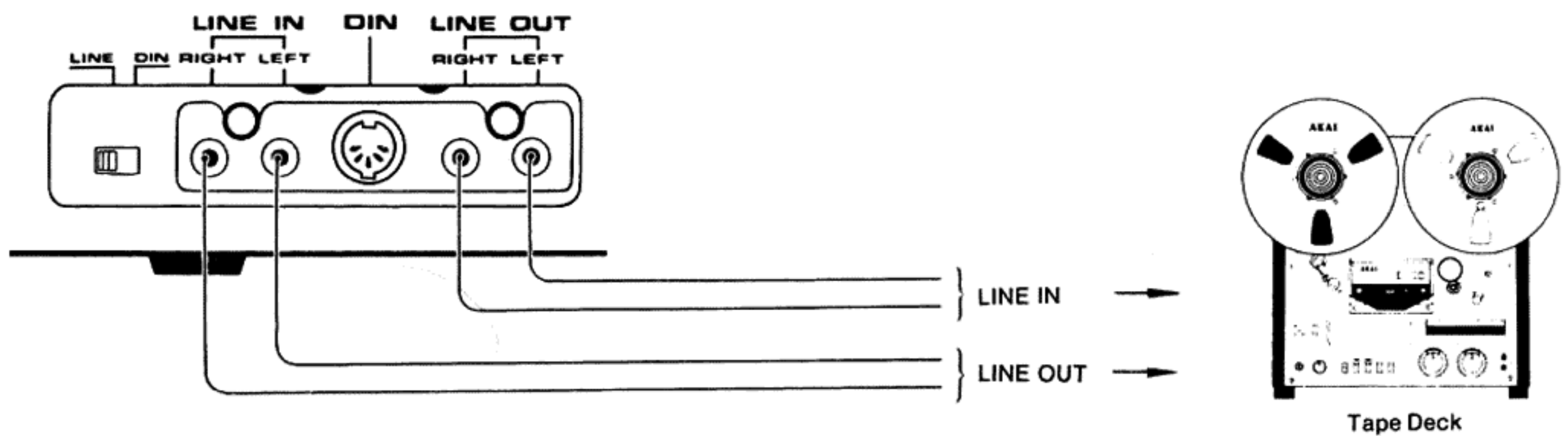

## CONNECTING A PAIR OF HEADPHONES AND MICROPHONES

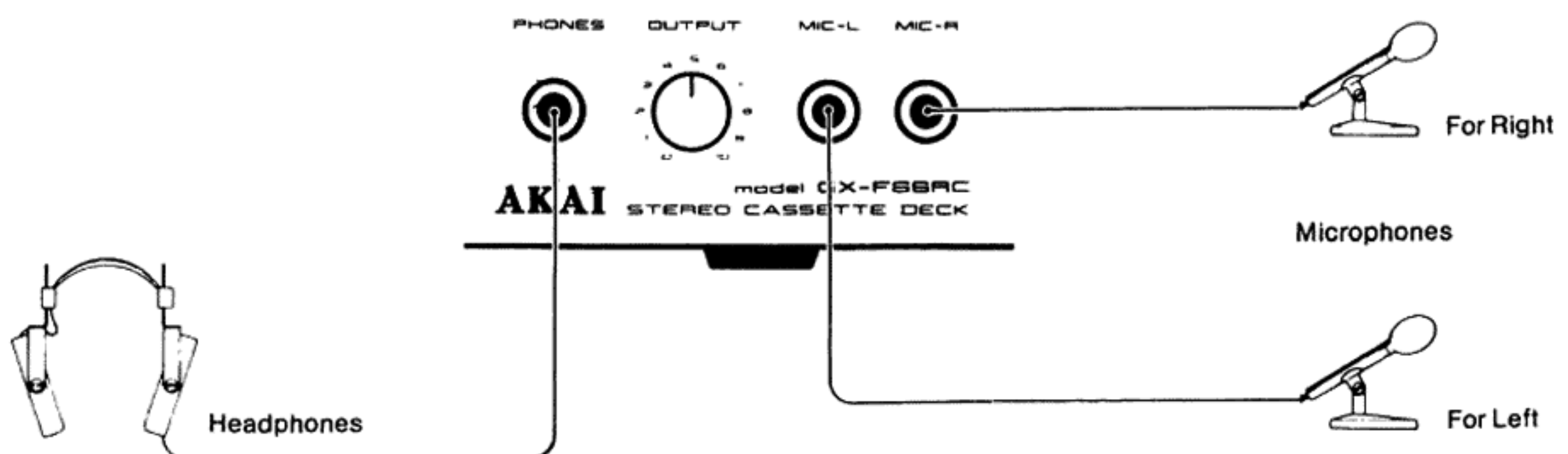

# RECORDING

## BASIC RECORDING PROCEDURE

Confirm the following before recording:

- The Power Cord is properly connected.
- All the components are properly connected.
- The TIMER START selector is set to OFF.

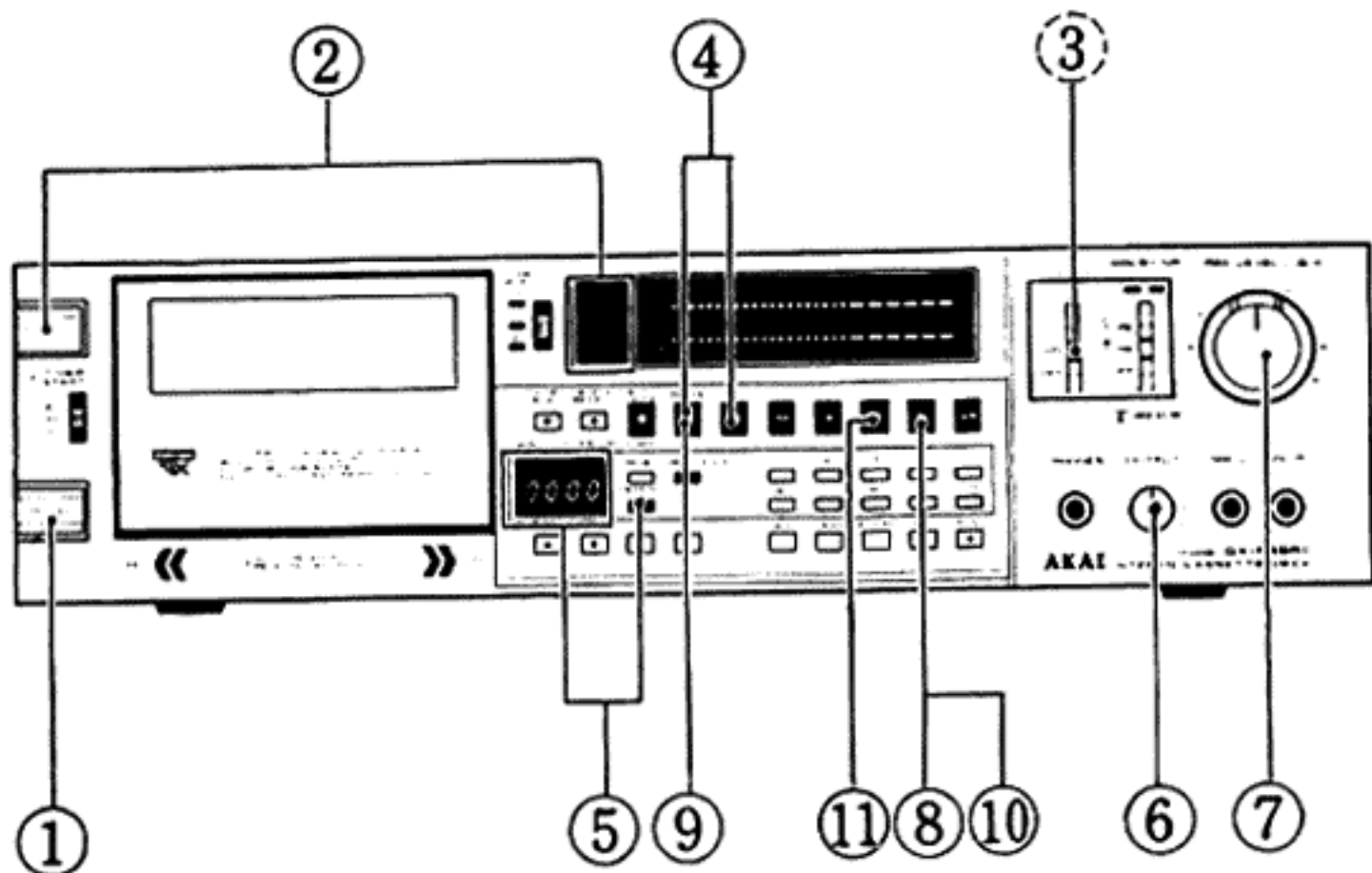

1. Press the POWER switch and turn on the power.
  2. Load a cassette. A new tape gives best result.
    - \* Confirm that the recording defeat tabs are not broken. If they are, cover the holes with pieces of adhesive tape.
  3. Set the DOLBY NR selector and FILTER switch.
  4. Press the Recording (REC ●) and PAUSE (■) buttons simultaneously to put the deck into recording standby.
  5. Press the RESET button and set the TAPE COUNTER/PROGRAM display to "0000".
  6. Adjust the OUTPUT control. Refer to HOW TO USE THE OUTPUT CONTROL on page 8.
  7. Set the recording input levels with the REC LEVEL controls. Adjust so that the VU levels read up to, but not exceeding 0 dB.
    - \* When recording with Dolby C-Type NR, adjust so that the VU levels are slightly below 0 dB.
  8. Press the Forward (▶) button to begin recording.
- To temporarily stop recording:
9. At the end of a selection, press the PAUSE (■) button to temporarily stop recording.
  10. To resume recording, press the Forward (▶) button just before the next selection begins.
  11. To stop recording, press the Stop (■) button.

### Note:

For proper functioning of Random Program Search System, Intro Scan System and Blank Search System, please create a blank space of more than 4 seconds at the beginning of Side A.

- \* The leader tape section is not considered a blank space.
- \* When recording from Side A to Side B, use the Quick Reverse.

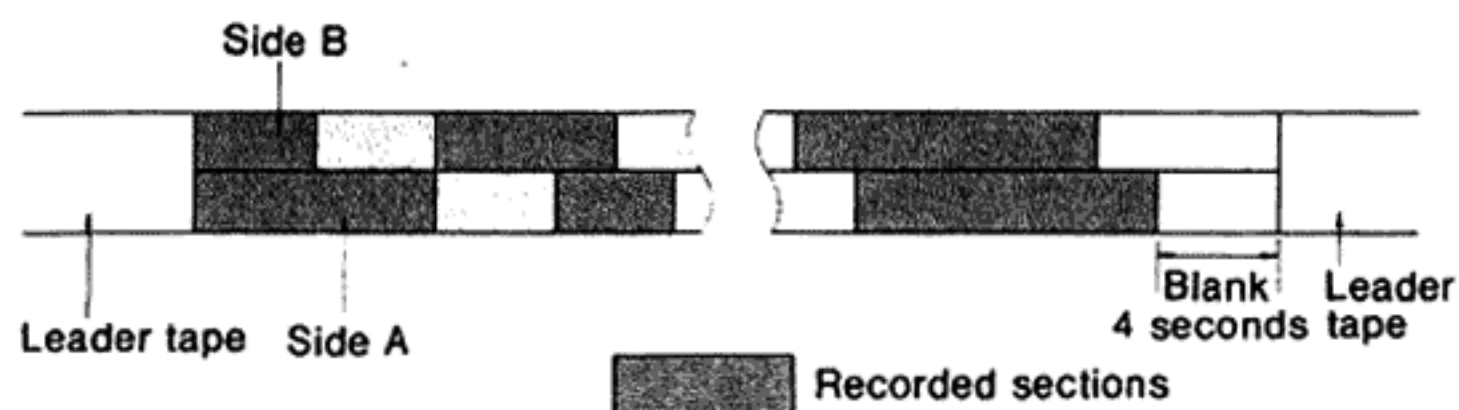

## AUTO MUTE SYSTEM

During recording, press the AUTO MUTE (●) button just once and no recording will be made on the tape for 4 seconds. The REC (●) button will flash on and off at one second interval. After 4 seconds, the deck will go into recording standby mode. For longer blank space, press and keep pressing the AUTO MUTE (●) button for as long as desired. When the button is released, the deck will go into recording standby mode. Use this button for editing, dubbing and for making the necessary blank spaces for RPSS.

### HOW TO USE

Use the AUTO MUTE (●) button instead of the PAUSE (■) button in step 9 of Basic Recording Procedure.

1. At the end of a selection, press the AUTO MUTE (●) button. The REC (●) button will flash on and off and after 4 seconds, the deck will go into recording standby mode.
2. To resume recording, press the flashing Forward (▶) or Reverse (◀) button just before the next selection begins.

#### To make blanks of less than 4 seconds

Press the AUTO MUTE (●) button and then press the PAUSE (■) button while the REC (●) button is flashing. The deck will go into recording standby mode. Press the flashing Forward (▶) or Reverse (◀) button to resume recording.

#### To make blanks longer than 4 seconds

Press and keep pressing the AUTO MUTE (●) button for as long as desired. The REC (●) button will flash at one second interval during this time. Release the button and the deck will go into recording standby mode. Press the flashing Forward (▶) or Reverse (◀) button to resume recording.

## BLANK SEARCH SYSTEM

The Blank Search System searches for the unrecorded portion on the tape which can be recorded. When this portion is reached, the deck goes into recording standby mode after creating 4 seconds of blank space.

Use this system when making additional recordings on a partially recorded tape.

When the BLANK SEARCH button is pressed, the deck fast forwards or rewinds the tape while in the playback mode (no sound is heard). When the deck finds the end of the last recorded section (i.e. the beginning of unrecorded portion), it creates 4 seconds of blank space and then goes into recording standby mode.

To start recording, press the flashing Forward (▶) or Reverse (◀) button.

- \* Do not touch any of the Operating buttons while the Blank Search System is searching for the unrecorded portion.
- \* Confirm that the cassette's recording defeat tabs are intact and if they are broken, cover the holes with pieces of adhesive tape. If cassette's recording defeat tabs are broken, the deck will go into pause mode and not recording standby mode.

## ADDED ON RECORDING

During playback, press the Forward (▶) or Reverse (◀) button which is lit and the REC (●) button simultaneously and deck will go into recording mode without stopping tape travel.

- \* Confirm that the cassette's recording defeat tabs are intact and if they are broken, cover the holes with pieces of adhesive tape.



## RECORDING CANCEL SYSTEM

When the REC CANCEL button is pressed during recording, the deck will rewind the tape to the beginning of the selection that was being recorded and go into recording standby mode after creating 4 seconds of blank space. If a blank space of less than 4 second is desired, press the PAUSE (■) button while the REC (●) button is flashing.

\* There must be a blank space of 4 seconds before the beginning of the selection for the Recording Cancel System to detect. Use the AUTO MUTE (●) button to create this necessary blank space.

### Note concerning Blank Search System and Recording Cancel System:

In some recordings like classics, there may be breaks of 4 seconds or more during a selection or there may be some parts where the sound is very low for 4 seconds or more. Such sections may be detected as blank spaces during Blank Search and Recording Cancel operations.

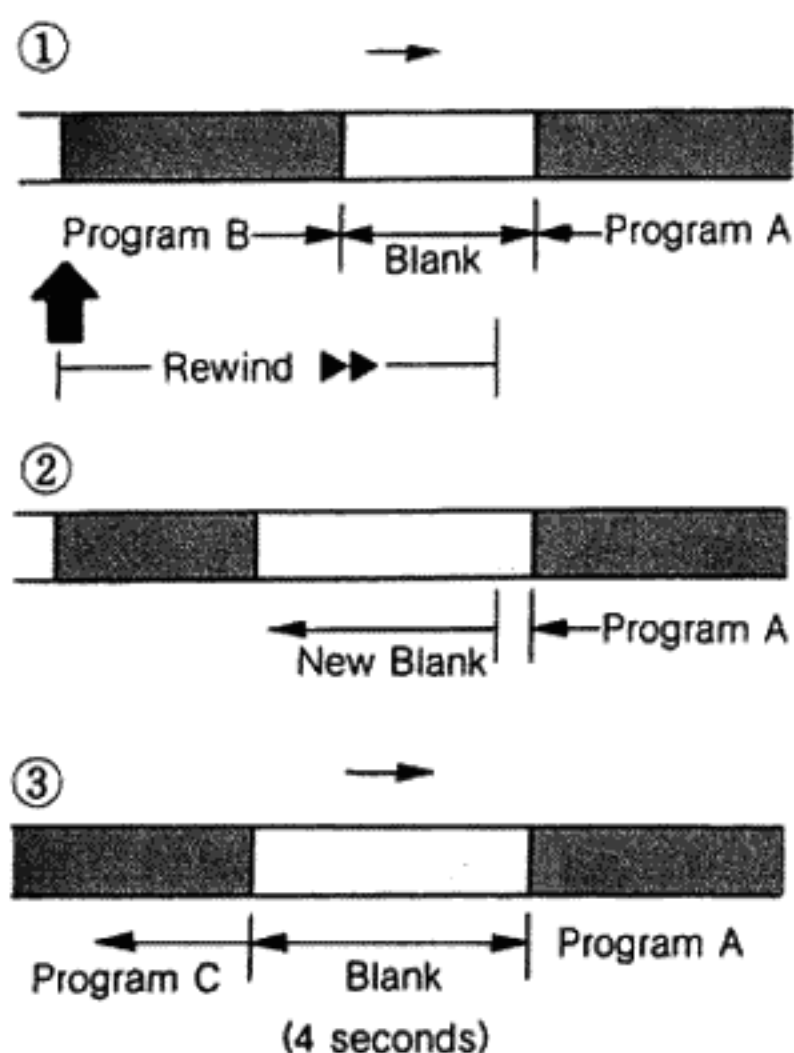

Press the REC CANCEL button anytime during recording (arrow in illustration).

The deck will rewind the tape to near the beginning of the blank space.

The deck will create 4 seconds of blank space and then go into recording standby mode.

Press the flashing Forward (▶) or Reverse (◀) button to begin recording.

## PLAYBACK

### BASIC PLAYBACK PROCEDURE

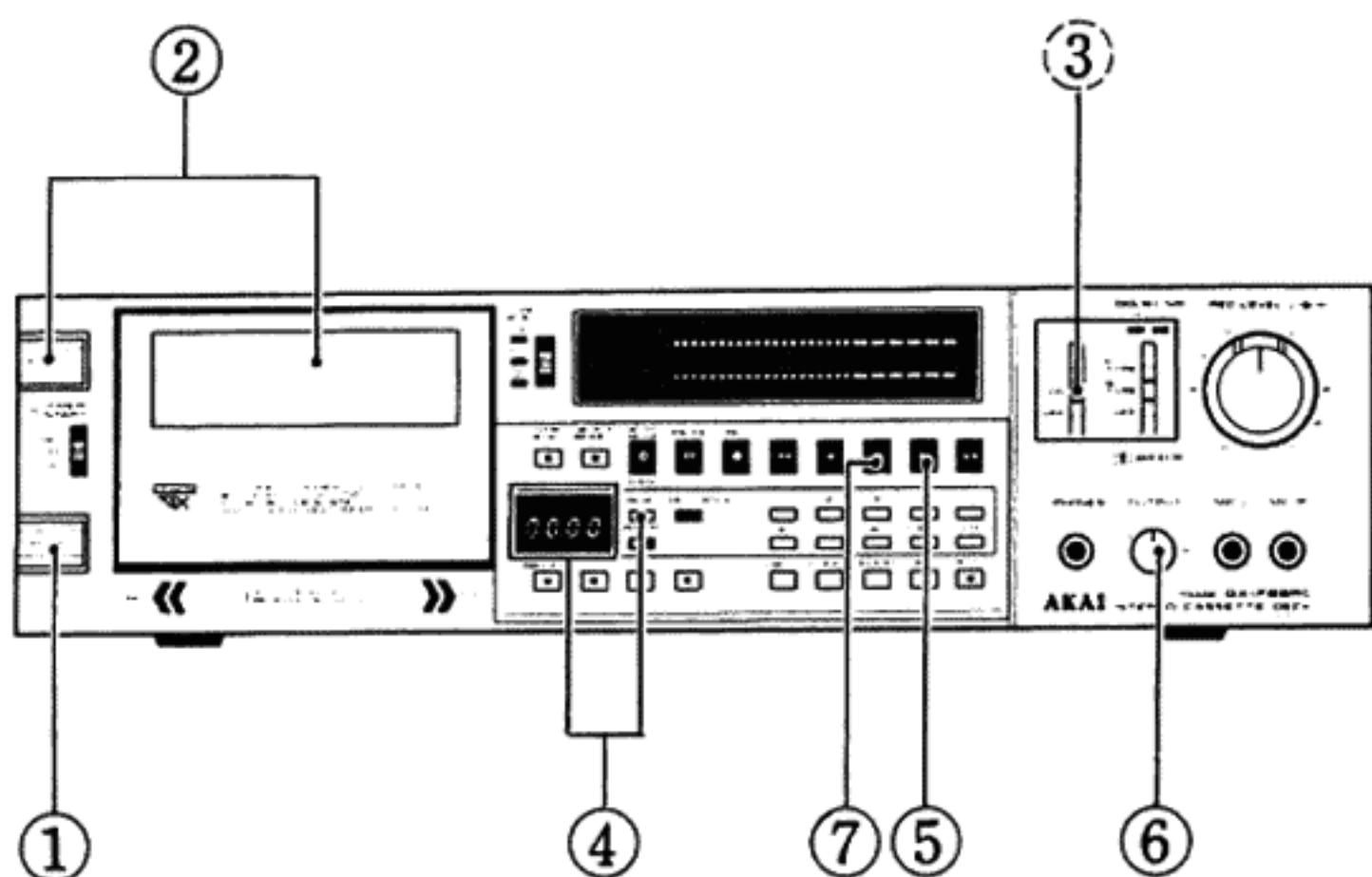

Confirm the following before playing back:

- The Power Cord is properly connected.
- All the components are properly connected.
- The TIMER START selector is set to OFF.

1. Press the POWER switch and turn on the power.
2. Load a cassette.
3. Set the DOLBY NR selector to the position it was set during recording and set the FILTER switch to OFF.  
\* If using a tape recorded with conventional Dolby NR, set the selector to B-TYPE.
4. Press the RESET button and set the TAPE COUNTER/PROGRAM display to "0000".
5. Press the Forward (▶) button to begin playback.
6. Adjust the output level with the OUTPUT control.
7. To stop playback, press the Stop (■) button.

### HOW TO USE THE OUTPUT CONTROL

When an external amplifier is employed, it is necessary to match the line output level of the deck with the playback level of the external amplifier so that when a tape is played back the amplifier's volume control need not be readjusted.

1. Consider the listening level of FM broadcast through the amplifier as standard.
2. Playback a prerecorded tape.
3. Set the Monitor selector of the amplifier to Tape and listen to the tape.

4. If the listening level is different from that of the standard listening level, adjust the deck's OUTPUT control.
5. Set the Monitor selector of the amplifier to Source and listen to the standard listening level.
6. If the listening level from the tape is still different from the standard listening level, adjust the OUTPUT control again.
7. Repeat steps 3 and 6 until there is no difference.

## AUTO SYSTEMS

### RANDOM PROGRAM SEARCH SYSTEM (RPSS)

This deck with its exclusive micro-computer can be programmed three different ways to play back selections on a tape: Sequential Play (SEQ), Random Play (RANDOM) and Skip Play (SKIP). Up to 20 selections from maximum of 99 selections can be selected to be played back in any order. And the program can be set to be repeated for maximum of 99 times. RPSS considers the tape as one long tape without Side A and B.

\* For the RPSS to function properly, there must be blank spaces of 4 seconds between the selections. Use the AUTO MUTE (●) button during recording to create these blank spaces.

1. **Sequential Play (SEQ)**  
Plays back only the selection desired. The desired selection may be entered in any order but they will be played back in the order they were recorded. If selection 1, selection 5 and selection 3 were entered in this order, selection 1, then selection 3 and then selection 5 will be played back.
2. **Random Play (RANDOM)**  
Plays back any selection in any order. Enter the selections as in Sequential Play but they will be played back in the order that they were entered: Selection 1, then selection 5 and then selection 3.
3. **Skip Play (SKIP)**  
Selections entered will be skipped. To play back only selections 1, 3 and 5, enter selections 2 and 4.
4. **Repeat (REPEAT)**  
Sequential Play, Random Play and Skip Play can be set to repeat for up to 99 times.



## BASIC PROGRAMMING

1. Press the PROGRAM key. The SEQ button will light and the deck will go into Sequential Play mode. The TAPE COUNTER/PROGRAM display will show only two digits.
2. If Random Play or Skip Play operation is desired, press the RANDOM key for Random Play or press the SKIP key for Skip Play.
3. Press the Programming key with the number corresponding to the desired selection. Confirm the number on the display and then press the SET key to memorize the number. Repeat until all the desired selections are programmed.
4. To repeatedly play back the programmed selections, press the Programming key to indicate the desired times the program is to be repeated and then press the REPEAT key.

## TO CONFIRM A PROGRAM

Press the Programming key corresponding to the order of selection. The number will be displayed. Then press the CALL key. The selection which corresponds to that order will be displayed. For example, if Programming key 2 is pressed, 2 will be displayed. When the CALL key is pressed, the second selection that is to be played back will be displayed. When "00" is displayed, it means that a selection has not been programmed for that order.

To confirm how many times a program is to be repeated, press the PROGRAM key 0 and then the CALL key. The number of times the program is to be repeated will be displayed.

## TO RUN A PROGRAM

After programming, press the RUN key. The deck will rewind or fast forward the tape to the beginning of the forward side of the tape and then begin playback. At the end of the program, the deck will go into stop mode.

## Example of RPSS System:

- 11 selections each on Side A and B.
- Random Play: ① selection 2 → ② selection 9 → ③ selection 5 → ④ selection 12 (Side B) → ⑤ selection 18 (Side B) → ⑥ selection 16 (Side B).  
Whole thing repeated twice.

## PROGRAMMING

1. Press the PROGRAM key.
  2. Press the RANDOM key.
  3. Press the Programming key 2 → press the SET key → press the Programming key 9 → press the SET key → 5 → SET → 1 → 2 → SET → 1 → 8 → SET → 1 → 6 → SET.
  4. Press the Programming key 2 and then press the REPEAT key.
- **To confirm the program**
5. To confirm the first selection to be played back, press the Programming key 1 and then the CALL key. To confirm the second selection to be played back, press the Programming key 2 and then the CALL key. To confirm the other selections, press the Programming key corresponding to the order of playback and then the CALL key.
  6. Press the 0 and then the CALL key to confirm the number of times the program is to be repeated.

- **To run the program**

7. Press the RUN key.

- **How to use the SKIP key**

During playback, when the SKIP key is pressed, the selection that is being played back will be skipped and the deck will go to the next selection in the sequence. If the SKIP key is pressed while selection 9 is being played back, the deck will skip that selection and begin playback of the next selection which is selection 5.

- \* During RPSS operation, when the SKIP button is depressed near the end of a selection, the blank space at the end of the selection may not be detected and the deck may skip to a selection after the actual selection in the program. Therefore, depress the SKIP button only during the first half of a selection.

## ERROR INDICATOR

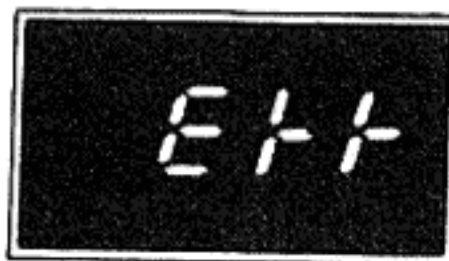

1. "Err" will be displayed if the deck is programmed beyond its capacity or if a program is programmed improperly.

2. "Err" will be displayed if a selection programmed does not correspond to the actual selection on a tape. For example, if the second selection programmed to be played back was selection 15 but there are only 12 selections on the tape.

## TO CANCEL A PROGRAM

To cancel a program during programming, press the CLEAR key. If the CLEAR key is pressed during running of a program, the deck will go into stop mode. Press the CLEAR key again and the program will be canceled. Even after the deck has played back according to a program, that program will be retained in the memory. Therefore, when reprogramming or when loading a different cassette, press the CLEAR key and cancel the old program first.

Also if any of the Operating buttons is pressed during running of a program, the RPSS will be released and the program canceled.

## NOTES ON RPSS

- In some recordings like classics, there may be breaks of 4 seconds or more during a selection or there may be some parts where the sound is very low for 4 seconds or more. Such sections may be detected as blank spaces between selections. With some live recordings, there may be applause between the selections. Such sections will not be detected as blank spaces between selections.
- The deck must be in the stop mode when programming for RPSS operation.
- For a selection to be repeated in a sequence, repeatedly program that selection when programming. Taking the example as an example, to make the second selection (selection 9) repeat playback two times, in step 3 of "Example of RPSS System", press the Programming key 2 → press the SET key → press the Programming key 9 → press the SET key → press the Programming key 9 → press the SET key → and the rest is the same.

## INTRO SCAN

Press the INTRO SCAN button and the beginning of a selection will be played back for 10 seconds. After 10 seconds, the tape will be fast forwarded or rewound to the beginning of the next selection and playback will take place for another 10 seconds. Beginning of all the selections will be played back in the same manner. This operation will be continued until the Stop (■) button is pressed.

- \* When the desired selection is played back, press the Forward (▶) or Reverse (◀) button which is lit and the deck will go into normal playback.
- \* Intro Scan can not be engaged if RPSS is engaged. To release the RPSS, press the Stop (■) button.



## AUTO PLAY

### Forward playback from rewind

Press the Rewind (◀◀) and the Forward (▶) buttons simultaneously.

- \* The Forward (▶) button will flash at approximately 1 second interval.
- \* If the Forward (▶) button is pressed when the tape is being rewound, the deck will go into forward playback.

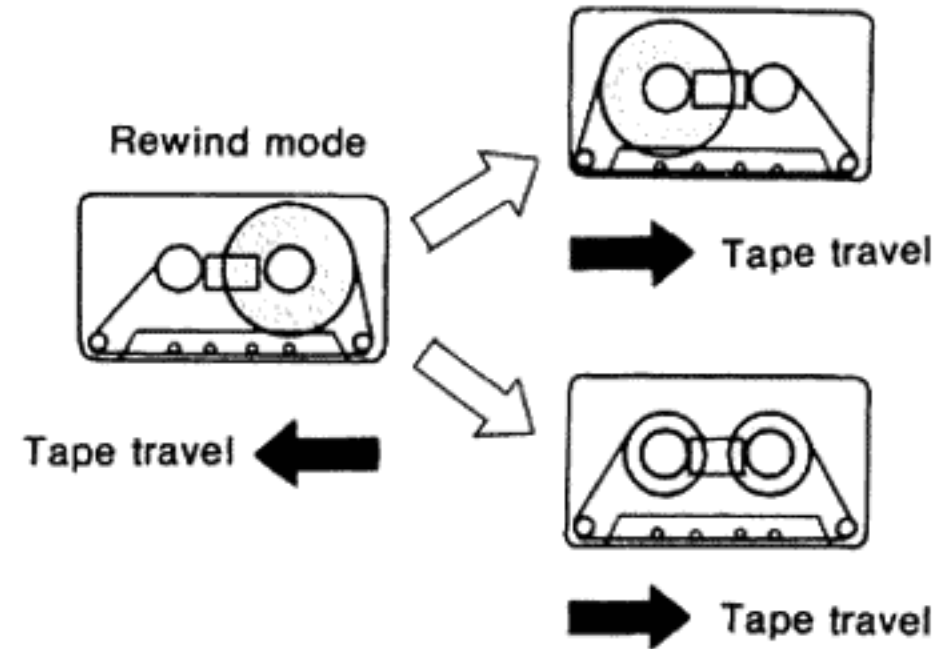

- \* At the beginning of the forward side of the tape, the deck will automatically go into forward playback.

- \* If the MEMORY switch was set to ON, the deck will rewind the tape to approximately "9999" and then begin forward playback.

9999

### Reverse playback from fast forward

Press the Fast Forward (▶▶) and Reverse (◀) buttons simultaneously.

- \* The Reverse (◀) button will flash at approximately 1 second interval.
- \* If the Reverse (◀) button is pressed when the tape is being fast forwarded, the deck will go into reverse playback.

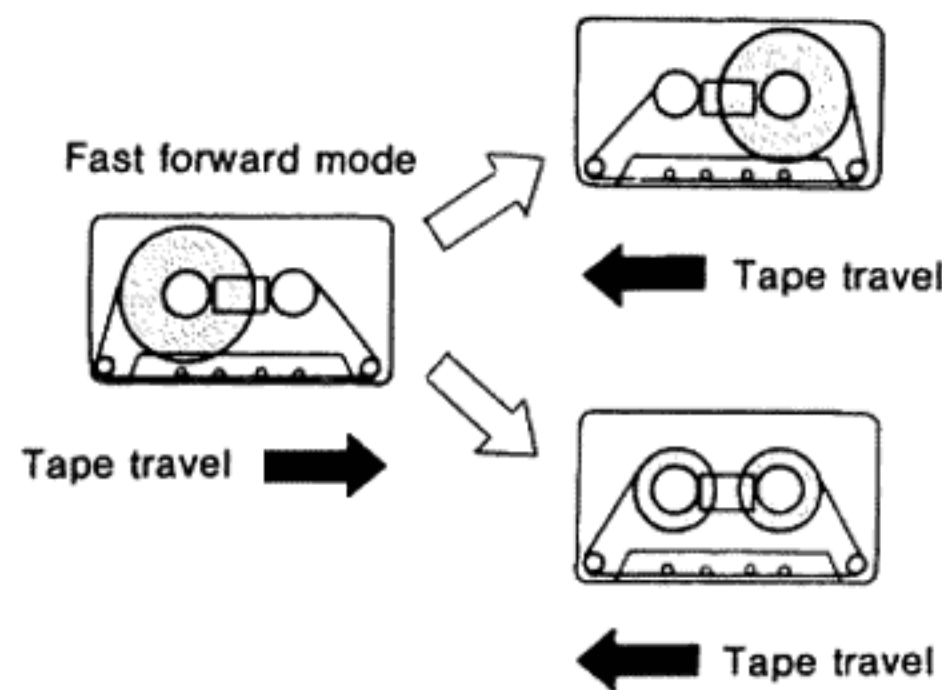

- \* At the beginning of the reverse side of the tape, the deck will automatically go into reverse playback.

- \* If the MEMORY switch was set to ON, the deck will fast forward the tape to approximately "0000" and then begin reverse playback.

0000

### Reverse playback from rewind

- (1) Set the MEMORY switch to ON.
- (2) Press the Rewind (◀◀) and the Reverse (◀) buttons simultaneously.

- \* The Reverse (◀) button will flash at approximately 1 second interval.
- \* If the Reverse (◀) button is pressed when the tape is being rewound, the deck will go into reverse playback.

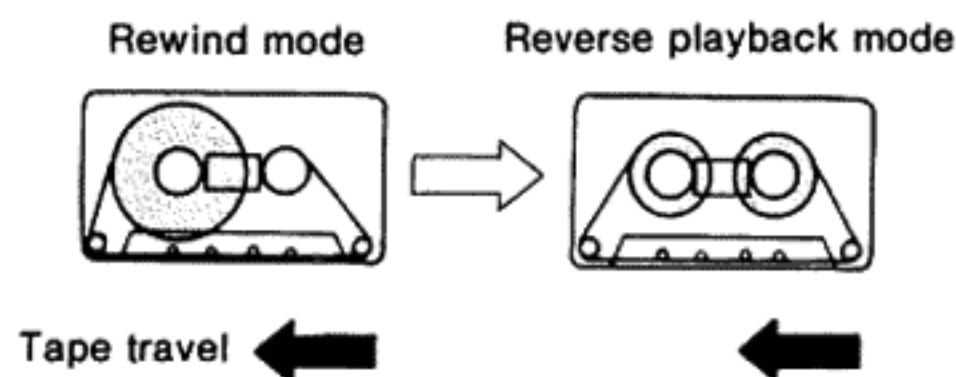

- \* The deck will rewind the tape to approximately "9999" and then begin reverse playback.

9999

### Forward playback from fast forward

- (1) Set the MEMORY switch to ON.
- (2) Press the Fast Forward (▶▶) and the Forward (▶) buttons simultaneously.

- \* The Forward (▶) button will flash at approximately 1 second interval.
- \* If the Forward (▶) button is pressed when the tape is being fast forwarded, the deck will go into forward playback.

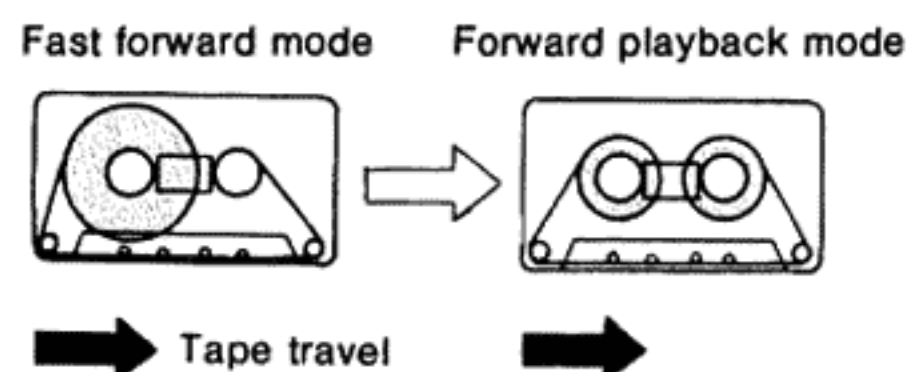





- \* The deck will fast forward the tape to approximately "0000" and then begin forward playback.

0000

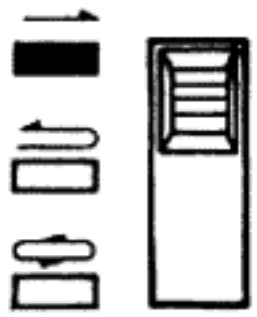
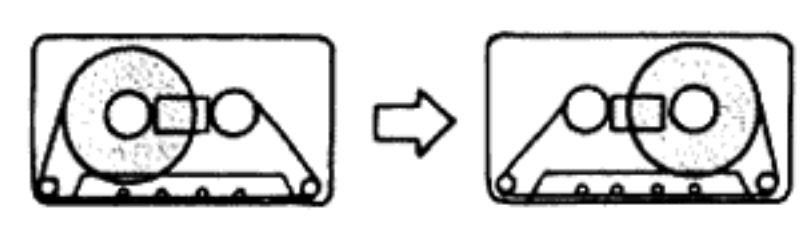
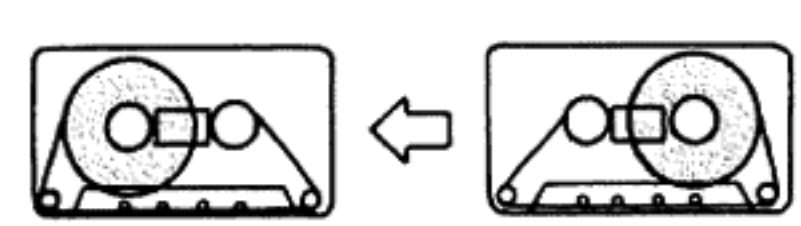
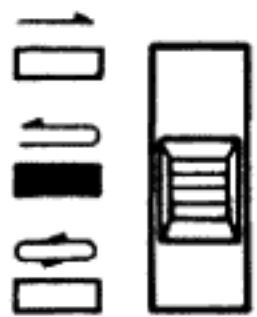
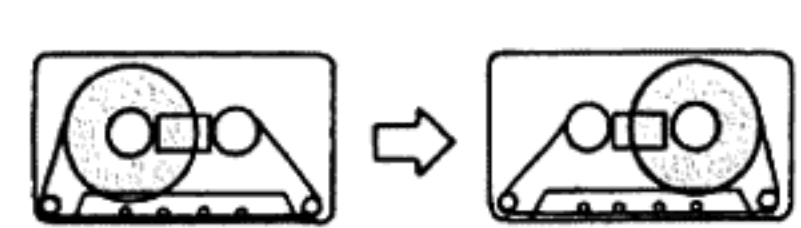
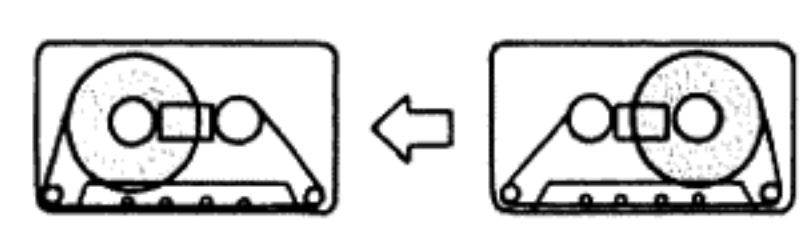

# REVERSE SELECTOR

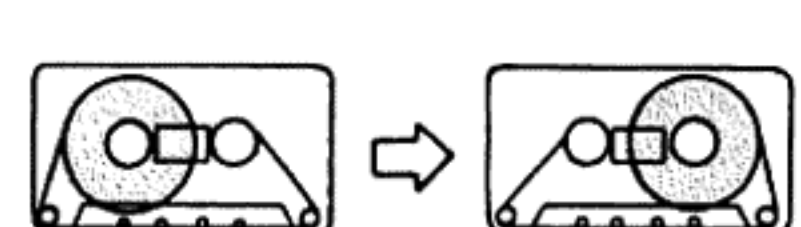
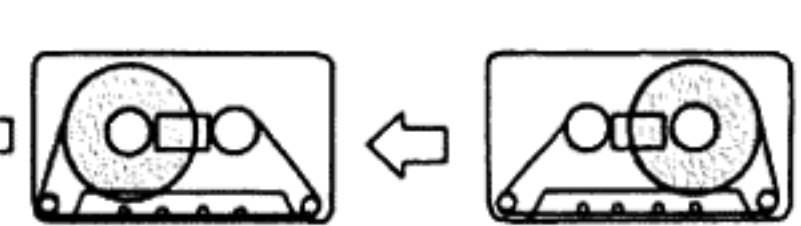
- For quick reverse operation, always use a tape with very clear leader tape sections.
- When a prerecorded tape is used for one-cycle (forward to reverse) recording, the first one second of the reverse side of the tape will not be erased. Please manually erase this section. If it is not erased, that section may be detected as a selection during RPSS operation.
- The position of the REV SELECTOR has no influence during Blank Search System, RPSS and Intro Scan operations.
- During quick reverse operation, no recording will be made for 0.5 second.

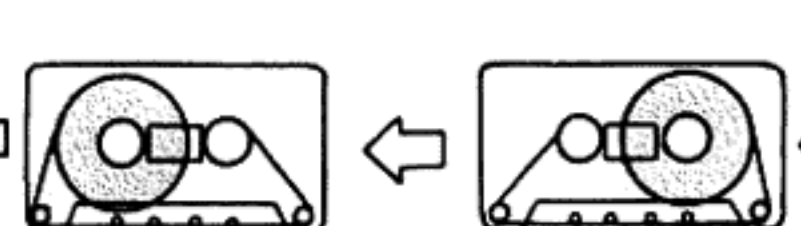
Position of REV SELECTOR	Explanation		RECORDING	PLAYBACK
<b>ONE-WAY</b>  	1 One-way forward recording or playback only	 <b>FWD</b>	1 Press the REC (●) and Forward (▶) buttons simultaneously.	1 Press the Forward (▶) button.
	2 One-way reverse recording or playback only	 <b>REV</b>	2 Press the REC (●) and Reverse (◀) buttons simultaneously.	2 Press the Reverse (◀) button.
<b>ONE CYCLE</b>  	3	 <b>FWD</b>	3 Press the REC (●) and Forward (▶) buttons simultaneously. The deck will go into one-cycle (forward to reverse) recording mode. * The deck will go into stop mode after reverse recording.	3 Press the Forward (▶) button. The deck will go into one-cycle (forward to reverse) playback. * The deck will go into stop mode after reverse playback.
	3'	 <b>REV</b>	3' Press the REC (●) and Reverse (◀) buttons simultaneously. The deck will go into one-way reverse recording. * The deck will go into stop mode after reverse recording.	3' Press the Reverse (◀) buttons. The deck will go into reverse playback only. * The deck will go into stop mode after reverse playback.
<b>CONTINUOUS</b>  	4	 <b>FWD</b>	4 Press the REC (●) and Forward (▶) buttons simultaneously. The deck will go into one-cycle (forward to reverse) recording mode. * After reverse recording, the deck will go into continuous playback. Press the Stop (■) button to stop playback.	4 Press the Forward (▶) or Reverse (◀) button. The deck will go into continuous playback. To stop playback, press the Stop (■) button.
	4'	 <b>REV</b>	4' Press the REC (●) and Reverse (◀) buttons simultaneously. The deck will go into one-way reverse recording. * After reverse recording, the deck will go into continuous playback. Press the Stop (■) button to stop playback.	
		 <b>FWD</b>		
		 <b>REV</b>		



# ABSENTEE RECORDING AND TIMED PLAYBACK

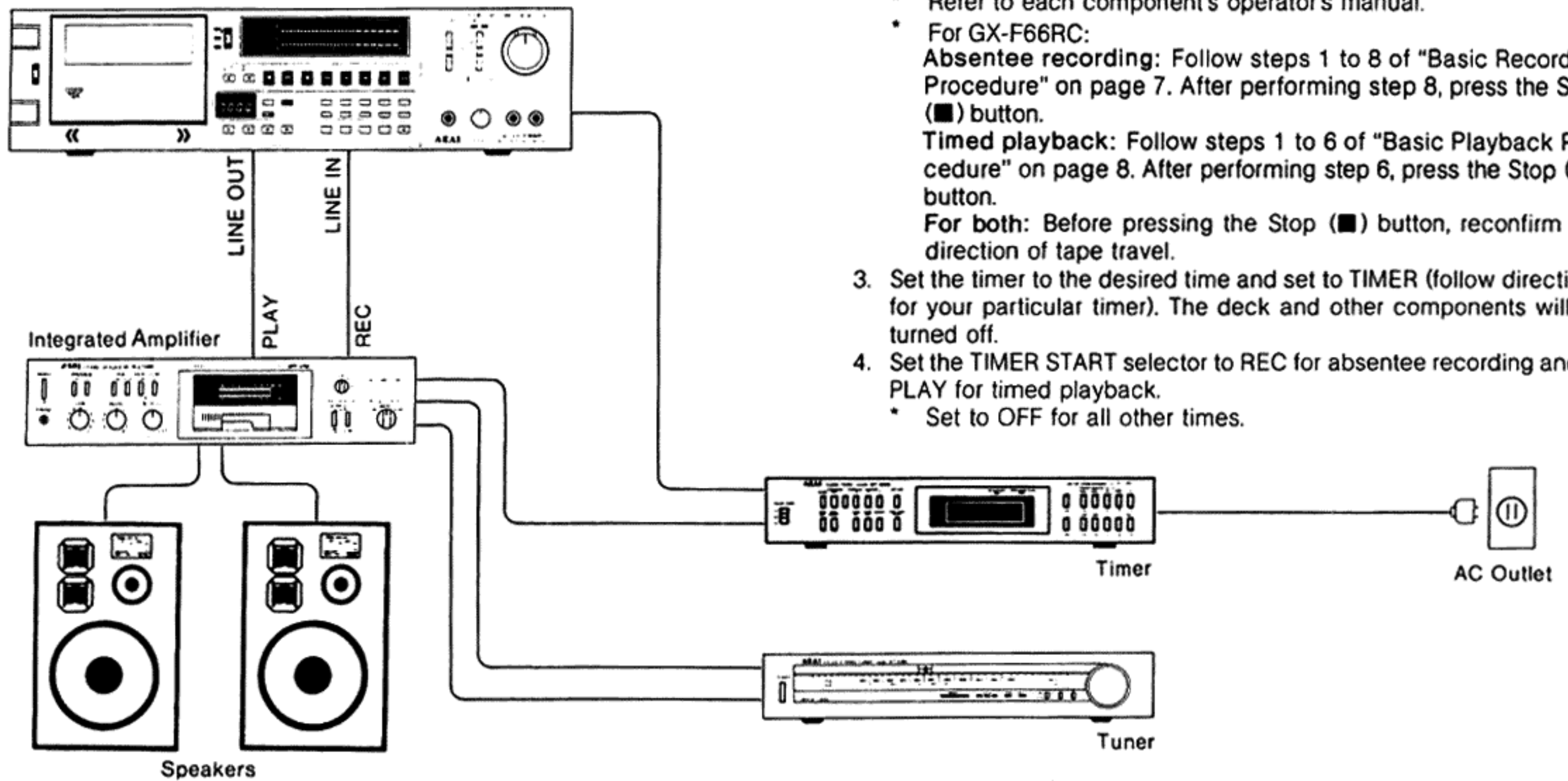

1. Set the timer to OFF (or similar mode: follow directions for your particular timer) when connecting the deck and other components.
2. Turn on all the components connected to the timer and make adjustments.
  - \* Refer to each component's operator's manual.
  - \* For GX-F66RC:  
**Absentee recording:** Follow steps 1 to 8 of "Basic Recording Procedure" on page 7. After performing step 8, press the Stop (■) button.  
**Timed playback:** Follow steps 1 to 6 of "Basic Playback Procedure" on page 8. After performing step 6, press the Stop (■) button.  
**For both:** Before pressing the Stop (■) button, reconfirm the direction of tape travel.
3. Set the timer to the desired time and set to TIMER (follow directions for your particular timer). The deck and other components will be turned off.
4. Set the TIMER START selector to REC for absentee recording and to PLAY for timed playback.
  - \* Set to OFF for all other times.

## MAINTENANCE

Turn off the POWER switch.

### 1. REMOVING THE RECEPTACLE LID

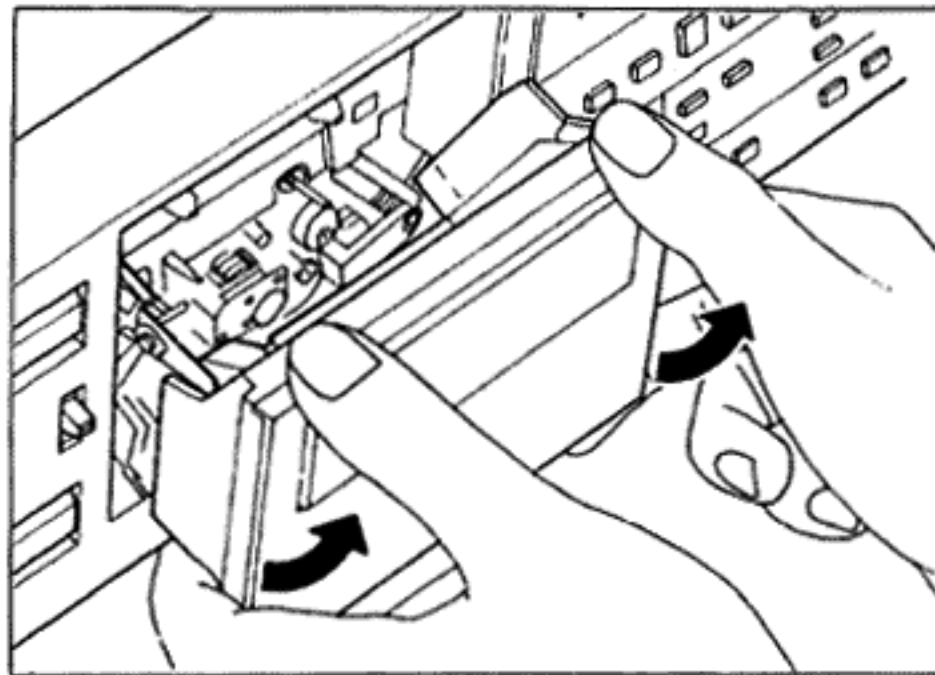

Depress the EJECT button and remove the cassette tape from the receptacle. The receptacle lid can be removed by lifting the lid and then pulling the lid toward you.

- \* Be sure to use both hands.

### 2. HEAD CLEANING

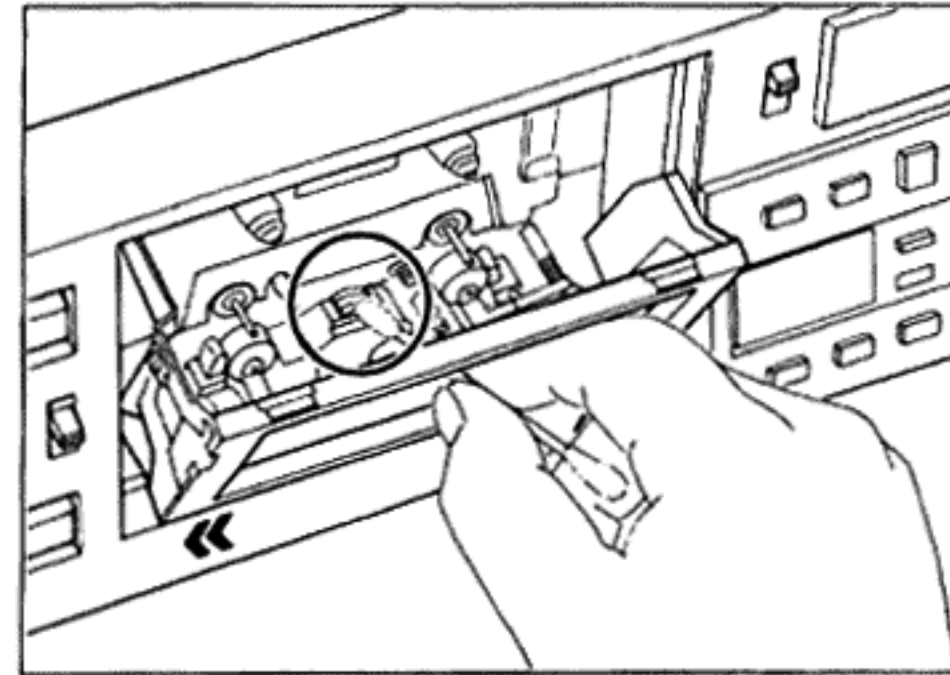

Clean the heads with a cotton swab stick which has been dipped in Akai Cleaning Fluid (Akai Cleaning Kit HC-550P). Also clean the pinch wheel, the capstan, and other parts over which the tape travels.

- \* If Akai Cleaning Fluid is not available, use alcohol. Do not use other chemical cleaners as the rubber parts will deteriorate.

### 3. HEAD DEMAGNETIZING

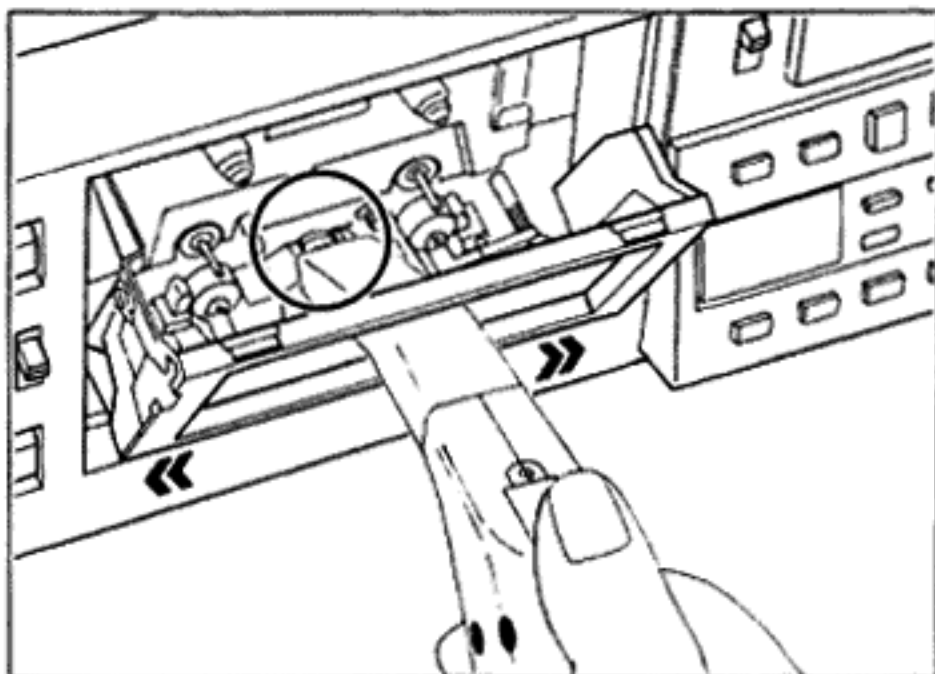

The steel pole pieces which form part of the recording and playback heads become slightly magnetized after several recording and playback hours and as a result, the tape is partially erased at high frequencies. Therefore, head demagnetizing is recommended periodically.

### 4. REPLACING THE RECEPTACLE LID

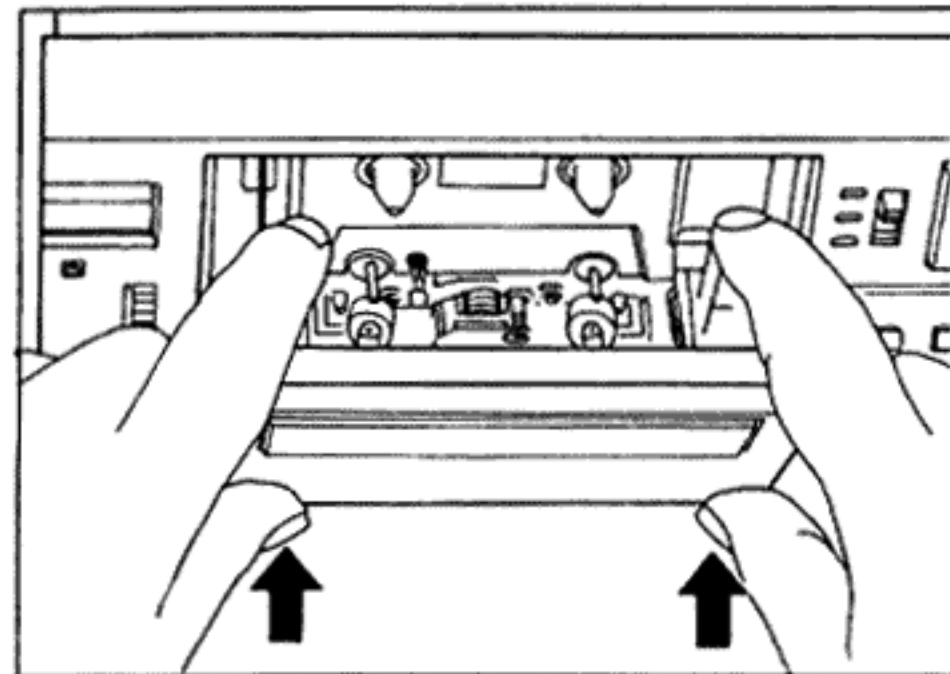

To replace the lid onto the holder, fit the two hooks on each side of the lid into the holes in the holder and then push the lid down.

- \* Do not insert a cassette tape with the receptacle lid off.
- \* The receptacle lid is properly attached when it is

even with the front panel.

## TROUBLE SHOOTING

The conditions listed below do not indicate mechanical failure of your unit. If your machine exhibits any of these conditions, check for trouble as indicated.

### Recording button will not function

- \* Cassette is not loaded.
- \* Cassette break-out tabs are removed. Plug or cover cavities.

### Tape will not run

- \* Power is not being supplied. Check power cord and POWER switch.
- \* Tape slack. Take up slack as mentioned in "Cassette Tape Care".

### Noisy Sound

- \* Heads are dirty. Clean following head cleaning instructions.
- \* Heads are magnetized. Demagnetize following head demagnetizing instructions.

### Previous recording will not erase

- \* Erase head dirty. Clean following head cleaning instructions.

### Distorted sound

- \* Recording level is too high. Use as explained under Recording.

### Playback cannot be effected

- \* Connections are incorrect.
- \* Controls are not properly adjusted or positioned. Check external amplifier controls.
- \* PAUSE ( ■■ ) Button is depressed.



### Recording will not take place

- \* Dirty head. Clean following head cleaning instructions.
- \* Connections are incorrect.
- \* Controls are not properly positioned or adjusted. Check external source controls.
- \* PAUSE ( ■■ ) Button is depressed.

### The correct indicator will not light when chrome tape is loaded

- \* Old cassette used. Use a new cassette with notches for triggering chrome position.

### Quick reverse will not take place

- \* REV SELECTOR not set to proper position. Set to  or .
- \* No leader tape sections or leader tape sections not clear enough. Use tape with leader tape sections or with clear leader tape sections.
- \* Sensor head dirty. Clean the sensor head.

### Tape stops during fast forward or rewind

- \* MEMORY switch set to ON. Set to OFF.

Should there be a problem with your machine, write down the model and serial numbers and all pertinent data regarding warranty coverage as well as a clear description of the existing trouble and contact your nearest authorized Akai Service Station or the Service Department of Akai Company, Tokyo, Japan.

## TECHNICAL DATA

<b>Track System</b> .....	4 Track 2 Channel Stereo System
<b>Tape</b> .....	Philips Type Cassette
<b>Tape Speed</b> .....	4.76 cm/s $\pm$ 1.5% (1-7/8 ips. $\pm$ 1.5%)
<b>Heads</b> .....	Twin Field Super GX head for recording/playback $\times$ 1 Erase head $\times$ 2
<b>Motors</b> .....	Electronically speed controlled D.C. motor for capstan drive $\times$ 1 D.C. motor for reel drive $\times$ 1
<b>Wow &amp; Flutter</b> .....	Less than 0.035% WRMS, 0.11% (DIN 45 500)
<b>Tape Winding Time</b> .....	80 sec. using a C-60 cassette tape
<b>Frequency Response</b> .....	Normal: 25 to 16,000 Hz $\pm$ 3 dB (-20 VU) CrO <sub>2</sub> : 25 to 17,000 Hz $\pm$ 3 dB (-20 VU) 25 to 9,000 Hz $\pm$ 3dB (0 VU) Metal: 25 to 19,000 Hz $\pm$ 3 dB (-20 VU) 25 to 13,000 Hz $\pm$ 3 dB (0 VU)
<b>Signal to Noise Ratio</b> .....	Normal: Better than 58 dB CrO <sub>2</sub> : Better than 60 dB Metal: Better than 60 dB (measured via tape with peak recording level) Dolby B-type NR switch ON: Improves up to 5 dB at 1 kHz, 10 dB above 5 kHz Dolby C-type NR switch ON: Improves up to 15 dB at 500 Hz, 20 dB at 1 kHz to 10 kHz
<b>Harmonic Distortion</b> .....	Normal: Less than 0.8% CrO <sub>2</sub> : Less than 0.7% Metal: Less than 0.7%

<b>Input</b> .....	MIC: 0.25 mV (input impedance 5.0 kohms) Required microphone impedance: 600 ohms Line: 70 mV (input impedance 47 kohms)
<b>Output</b> .....	Line: 410 mV at 0 VU Required load impedance: more than 20 kohms Phone: 1.3 mW/8 ohms at 0 VU
<b>DIN</b> .....	Input: 2.0 mV (input impedance 10 kohms) Output: 410 mV Required load impedance: more than 20 kohms
<b>Power Requirements</b> .....	120V, 60 Hz for USA and Canada 220V, 50 Hz for Europe except UK 240V, 50 Hz for UK and Australia 110V/120V/220V/240V, 50/60 Hz switchable for other countries
<b>Dimensions</b> .....	440(W) $\times$ 118(H) $\times$ 309(D)mm (17.3 $\times$ 4.6 $\times$ 12.2")
<b>Weight</b> .....	8.6 kg (19.0 lbs)

### STANDARD ACCESSORIES

Connection Cords .....	1 set
Operator's Manual .....	1

- \* For improvement purposes, specifications and design are subject to change without notice.
- \* "Dolby" and the Double D symbol are trademarks of Dolby Laboratories.  
(Manufactured under license from Dolby Laboratories)



**AKAI**

AKAI ELECTRIC CO., LTD.  
12-14, 2-chome, Higashi-Kojiya,  
Ohta-ku, Tokyo, Japan



© 561111B1  
561117-2